

Boreal 130C

Notice d'installation



Modèle Boreal 130C

1300x1300x2000mm

Tension : AC220-240V









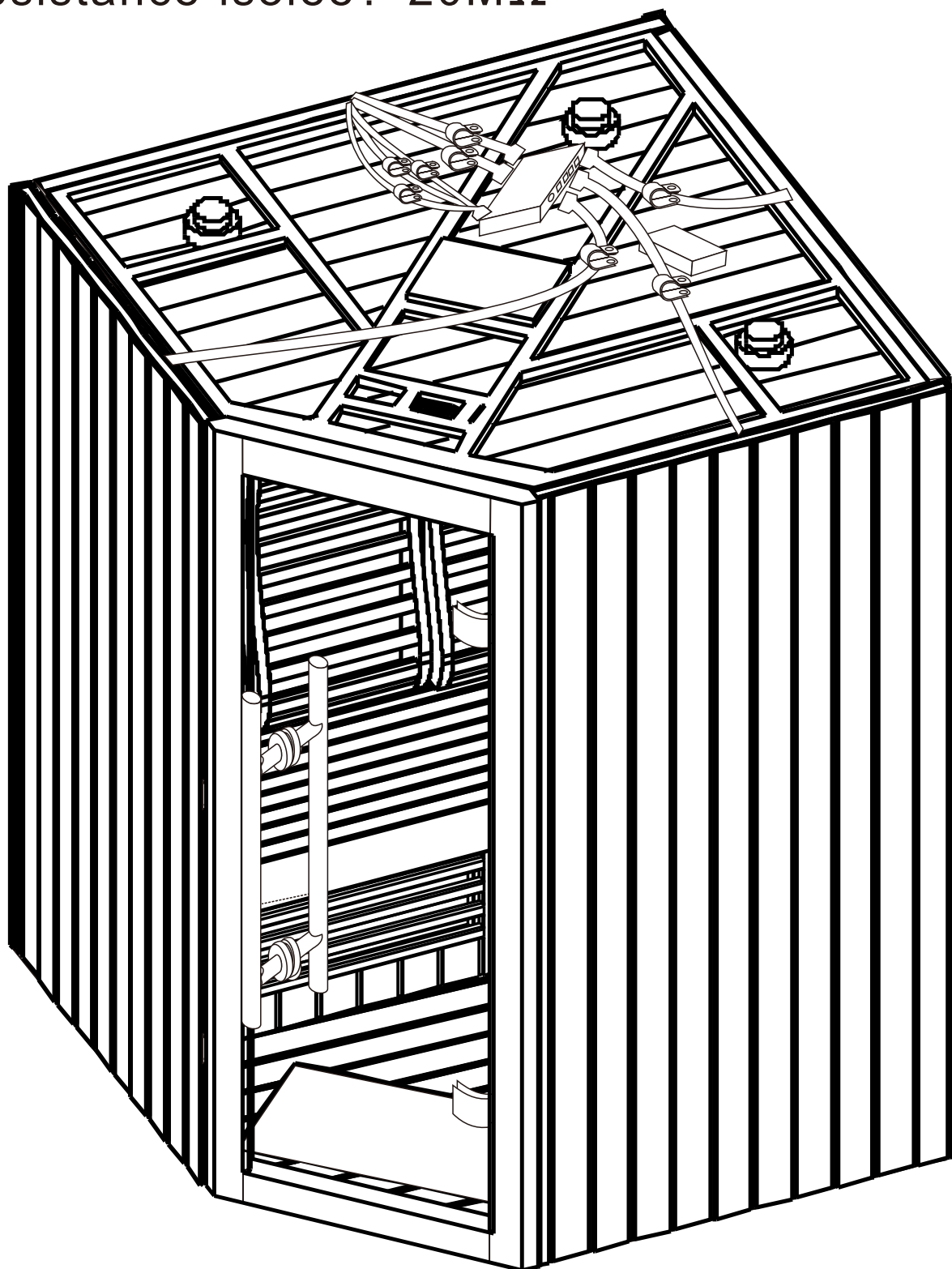

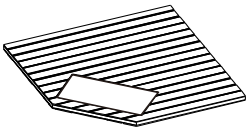

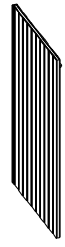
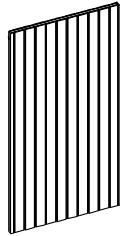
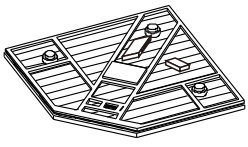
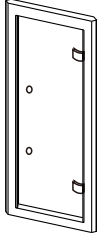

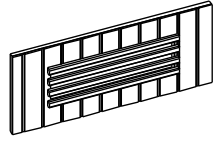
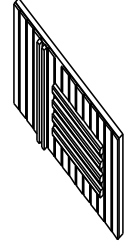
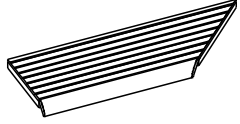
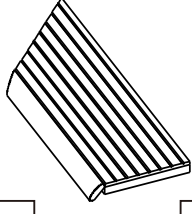
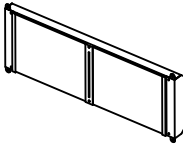
Puissance : 2660W

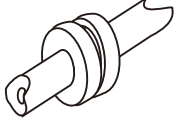
Courant : 12.1A

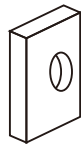
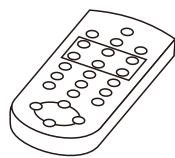
Fréquence nominale: 50/60HZ

Résistance isolée : >20MΩ

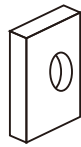
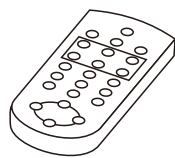

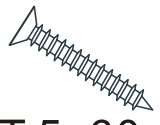
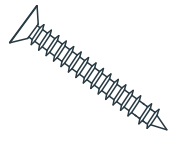
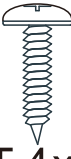
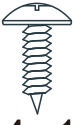
				
01	X102	X103	X104	X105
				
06	X107	X108	X409	X110
				
11	X112	X113	X214	X215
				
16	X8	X8	X119	X10
				
17	X8	X8	X10	X5
				
ST 5x60	ST 5x70	ST 4x18	ST 4x12	
21	X10	22	X8	23
		X8		X15

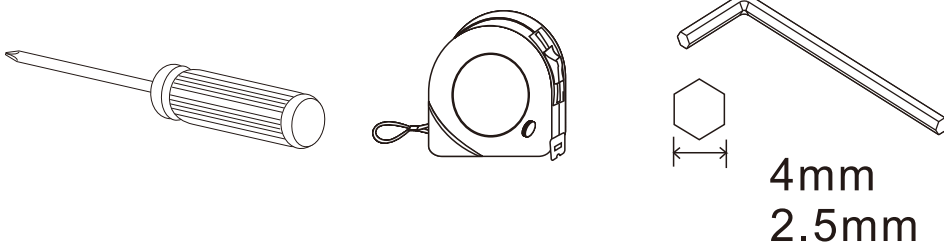

P01

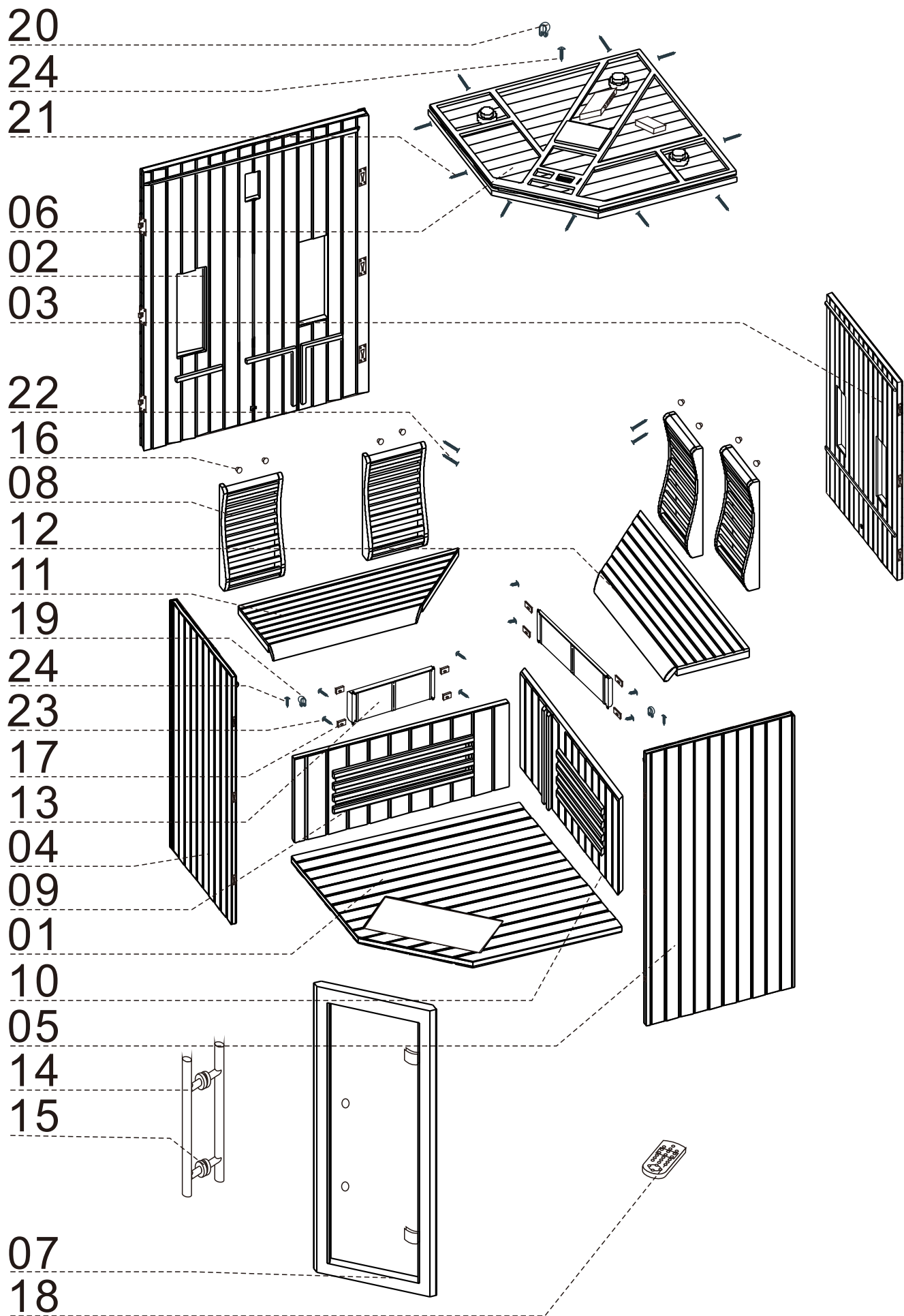

P02

Etape 1

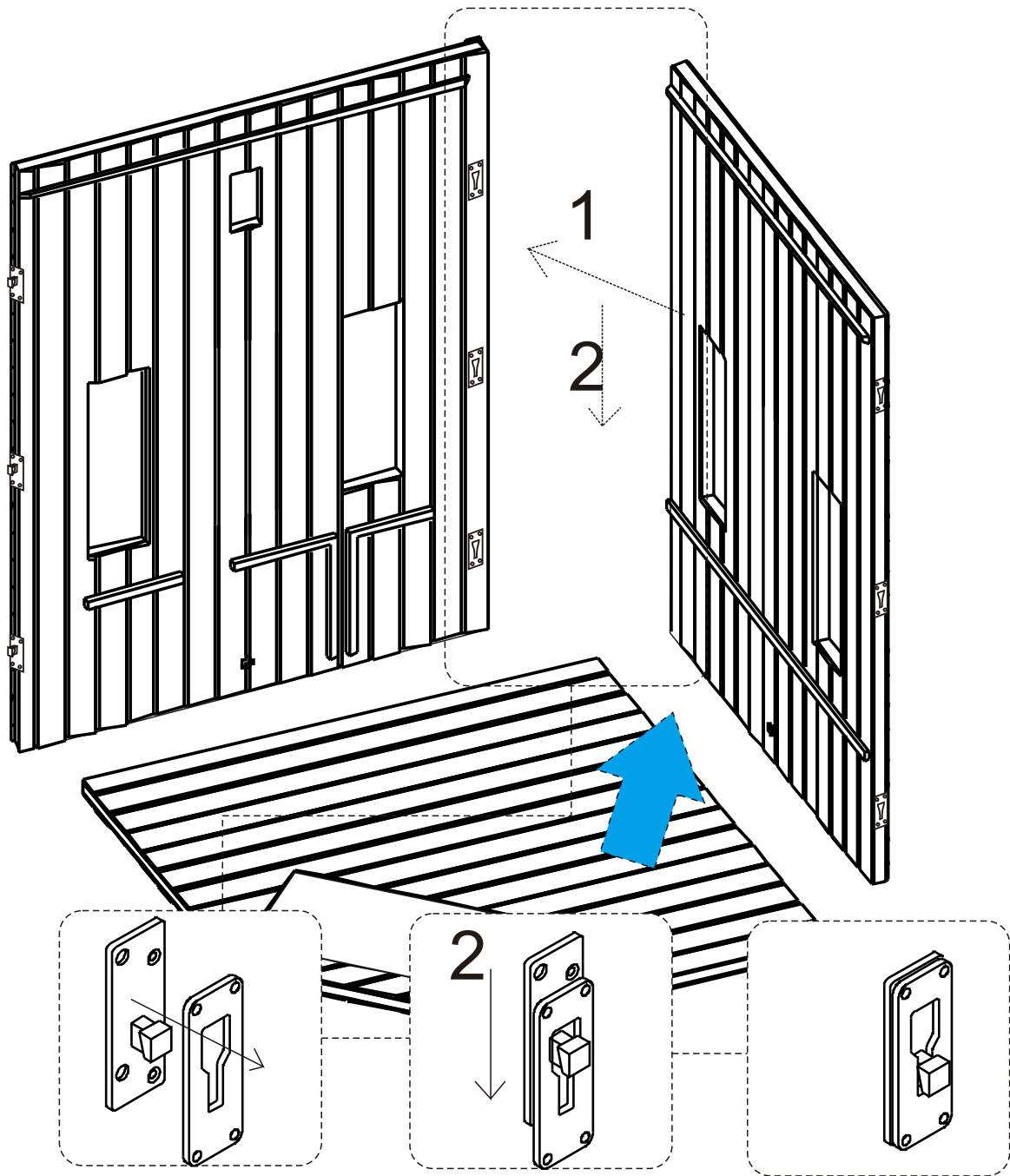
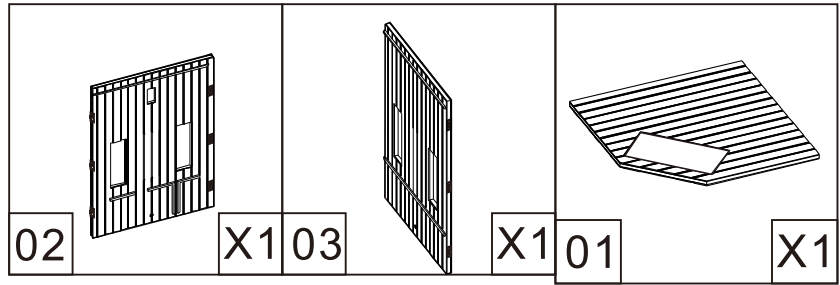

P03

Etape 2

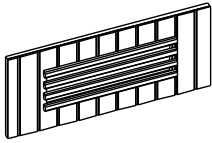
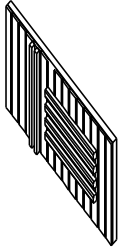
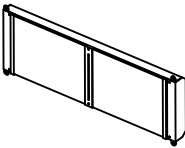
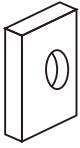
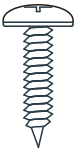
					
09	X1 10	X1 13	X2 17	X8 23	X8

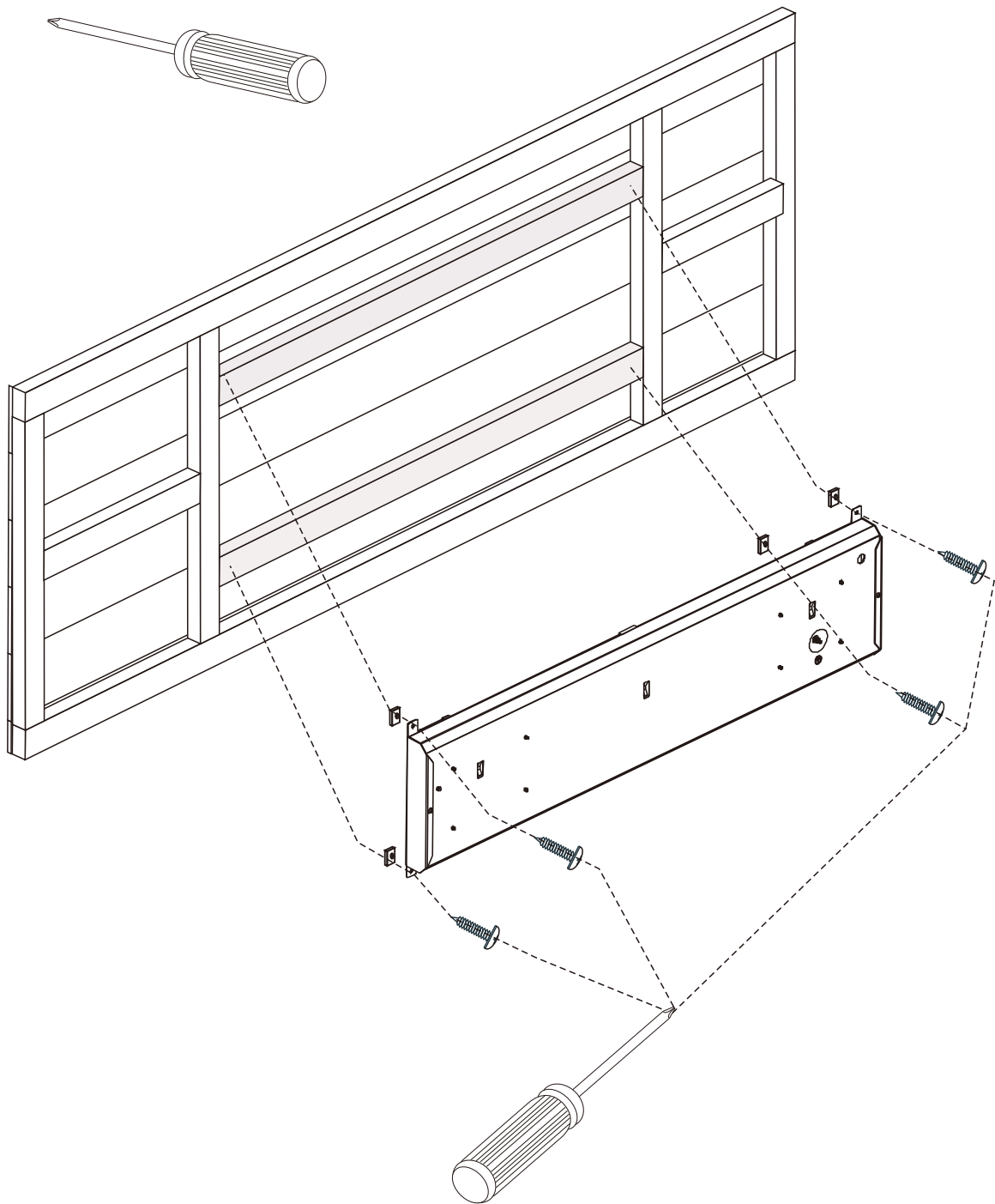

P05

Etape 3

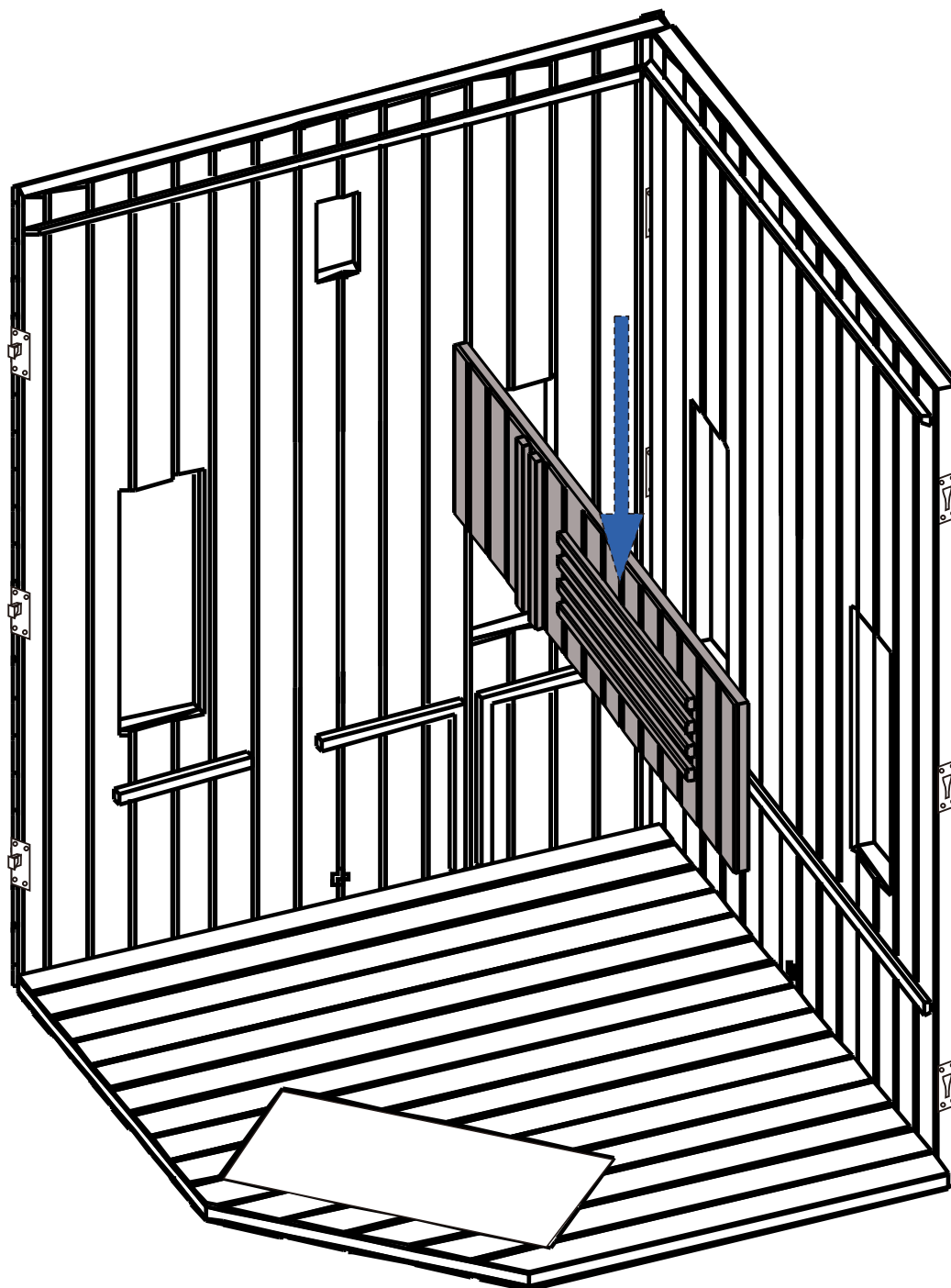
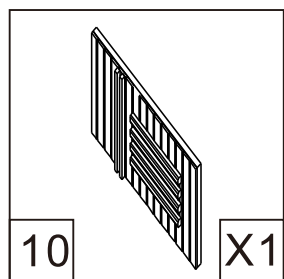

P06

Etape 4

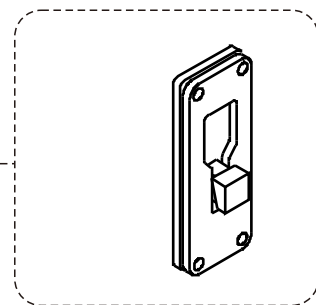
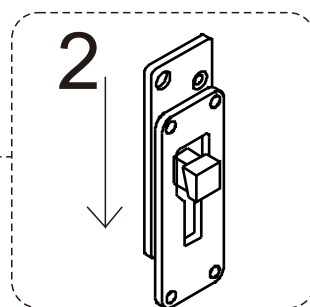
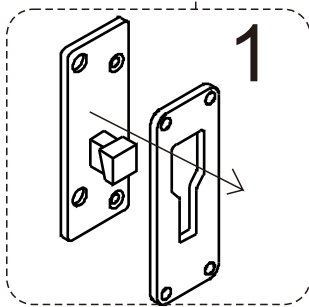
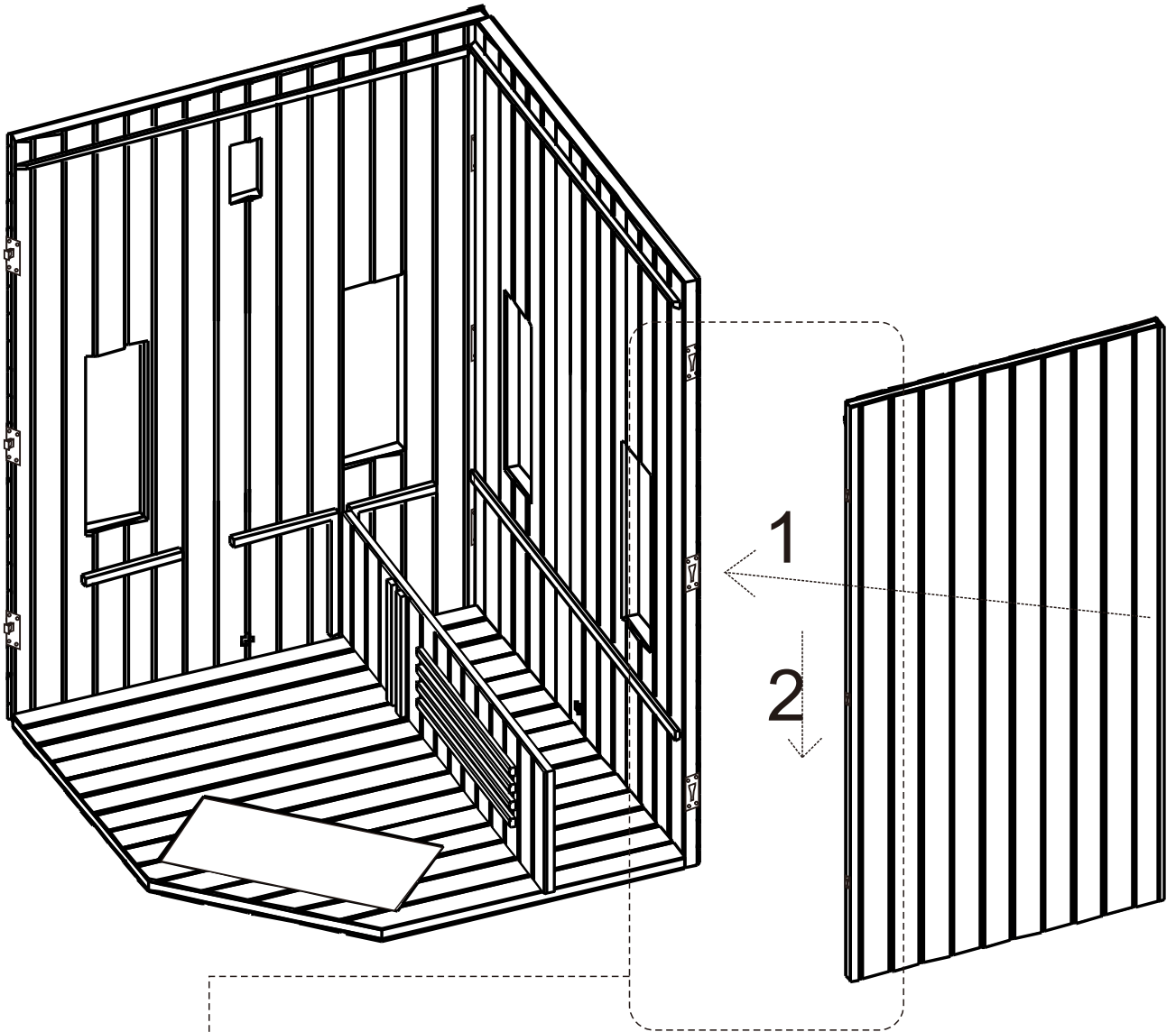
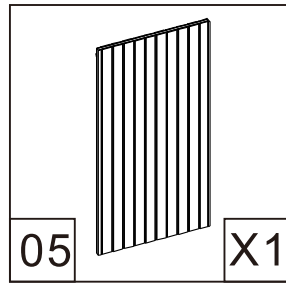

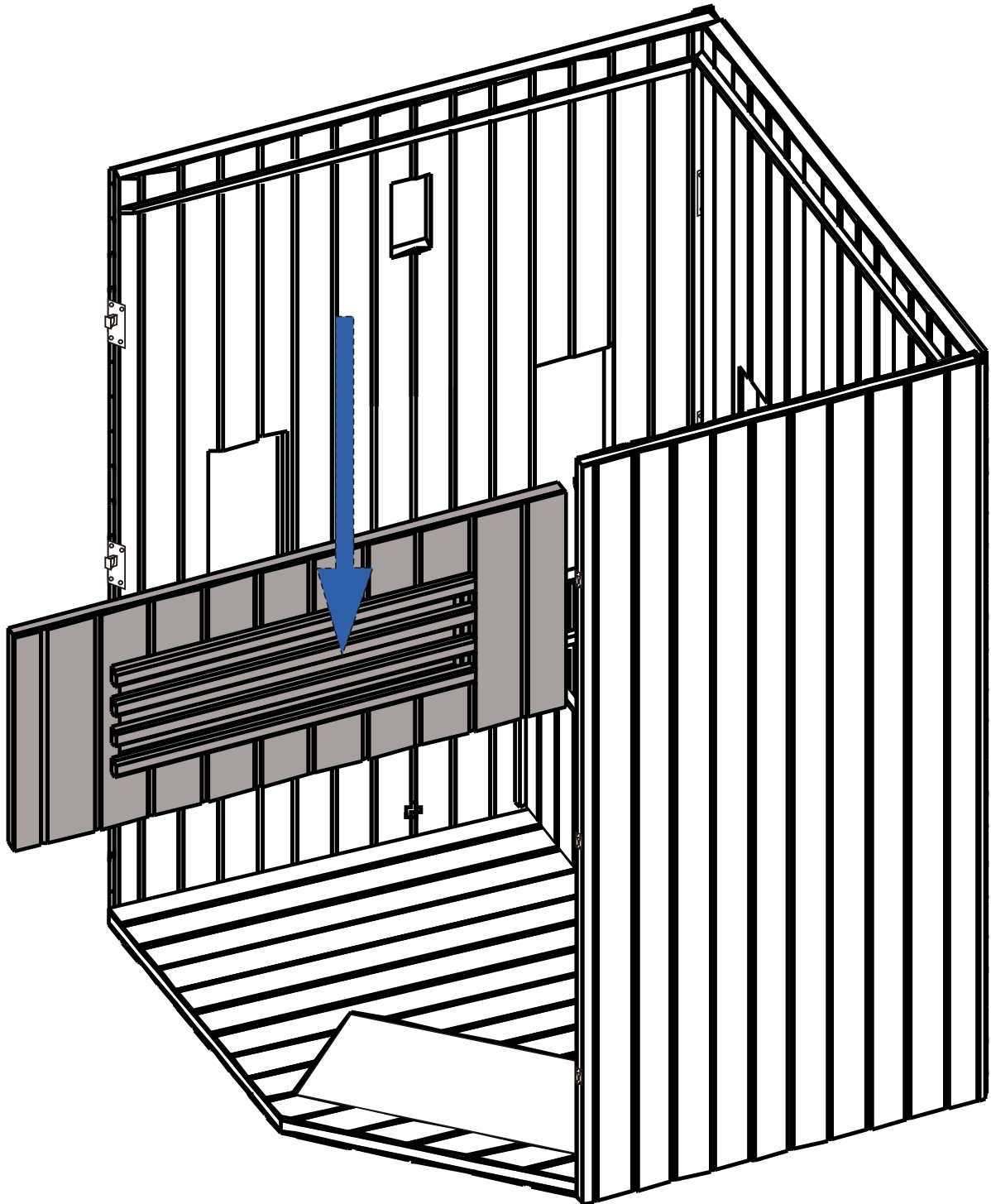
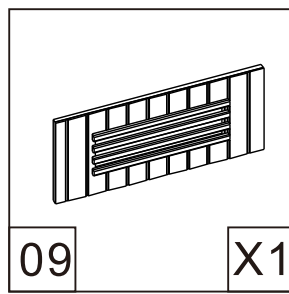

P07

Etape 5



P08

Etape 6

 ø8	 ST 4x12		
19	X3	24	X3

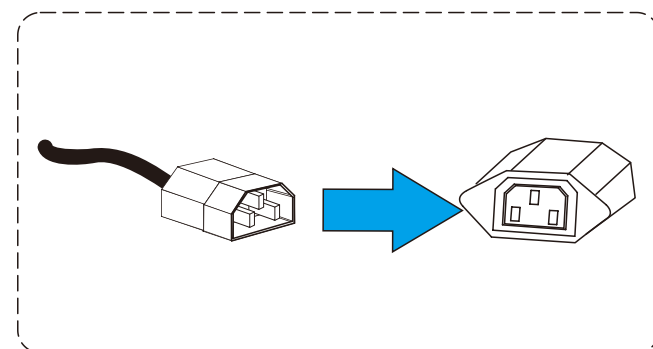
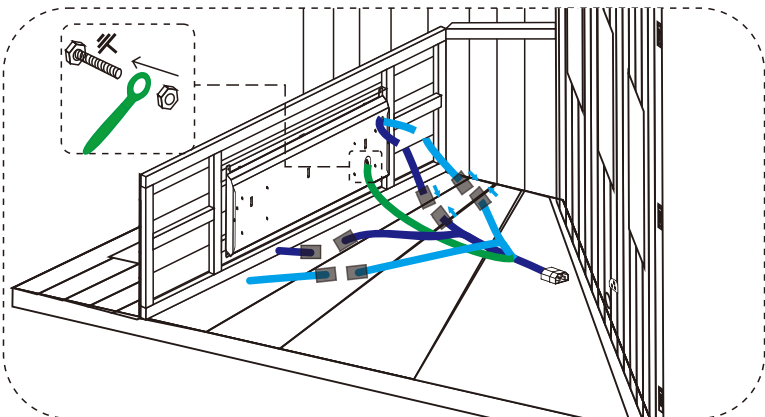
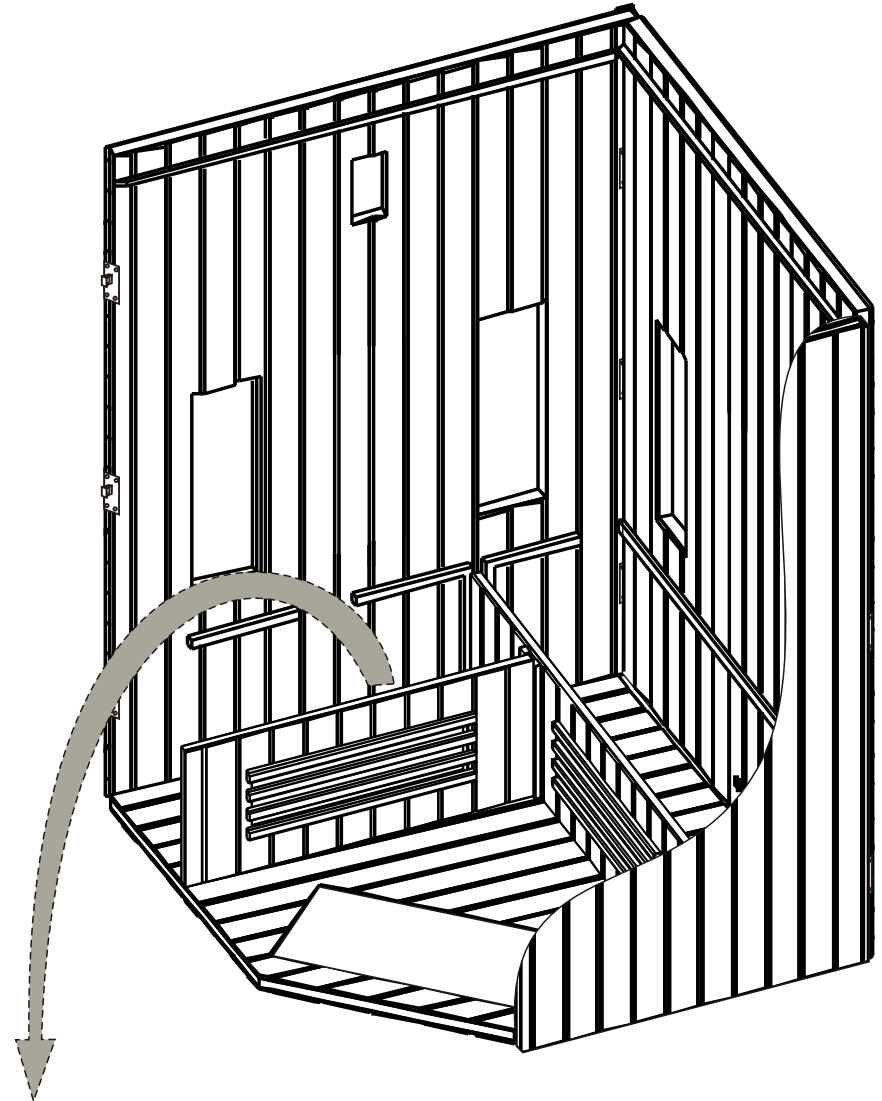
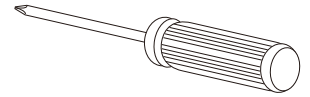

P09

Etape 7

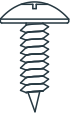
 ø8	 ST 4x12		
19	X2	24	X2

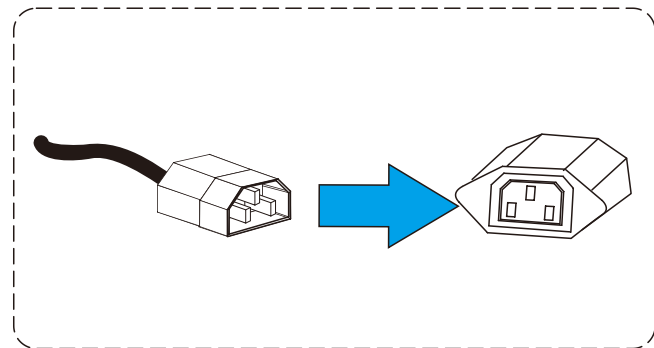
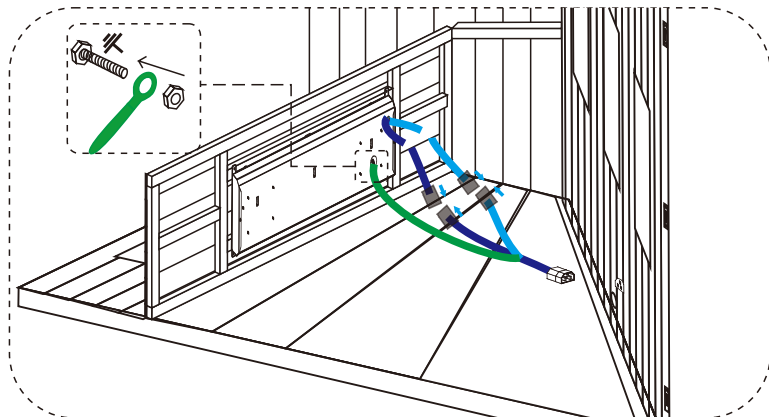
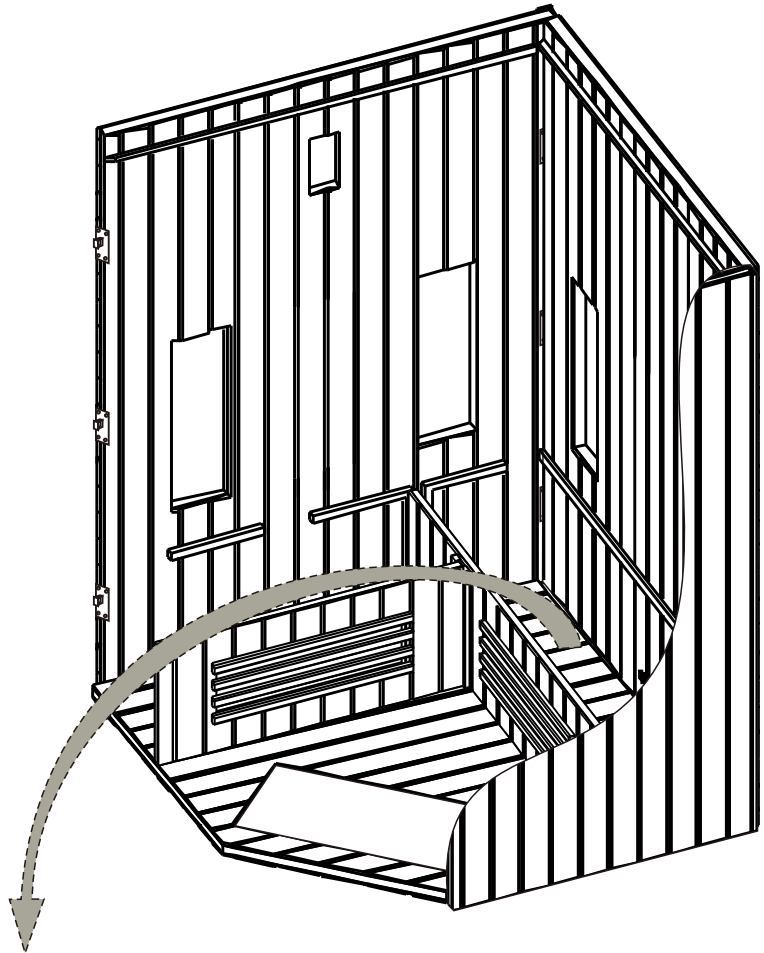
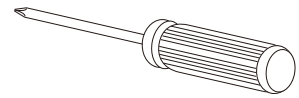

P10

Etape 8

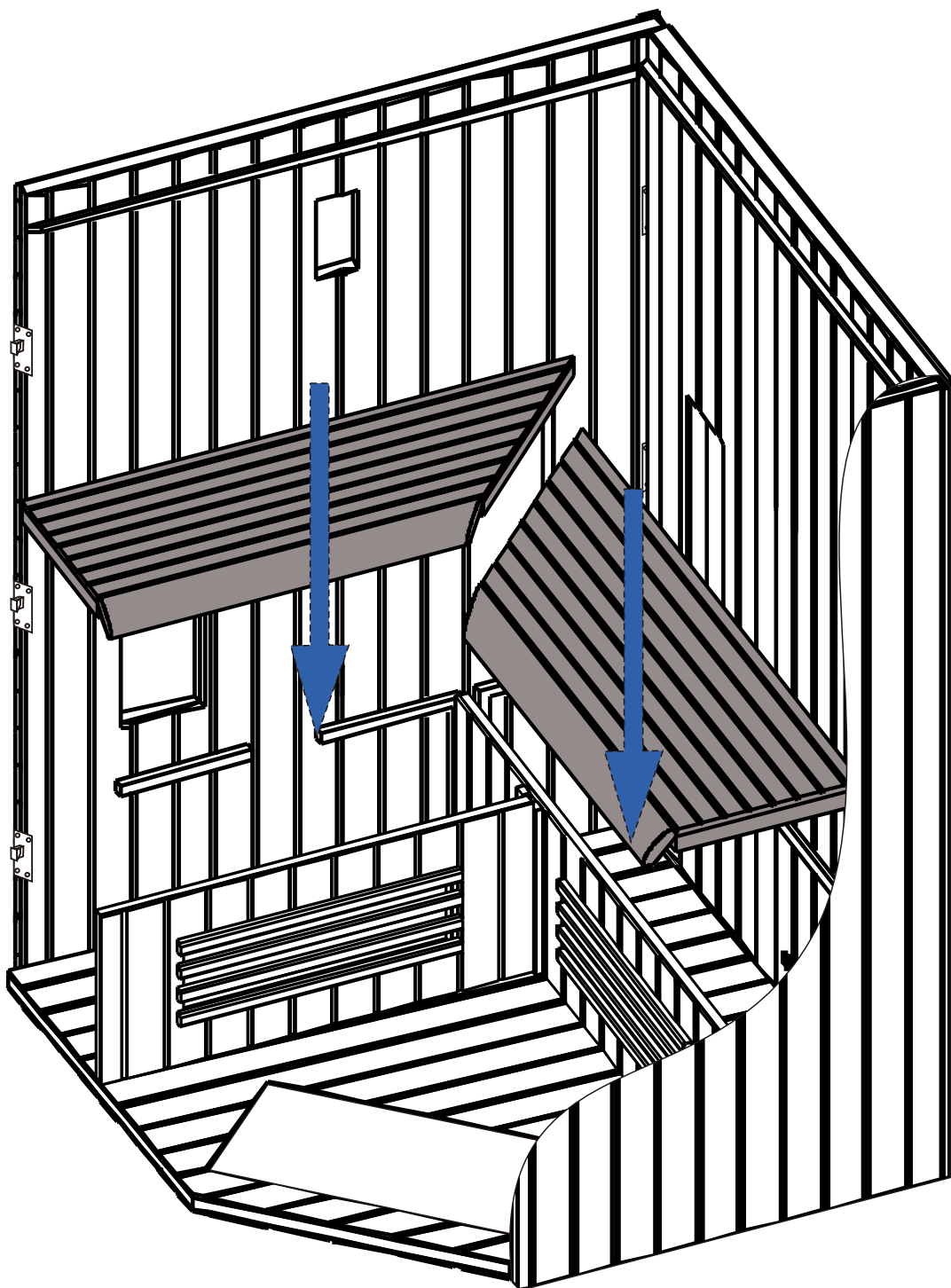
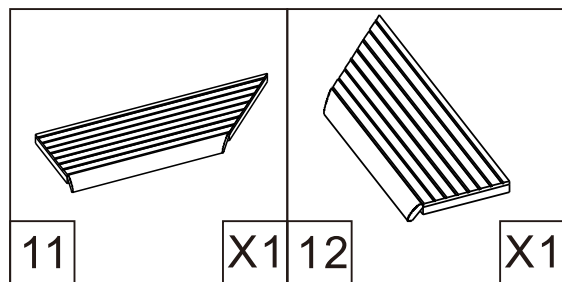

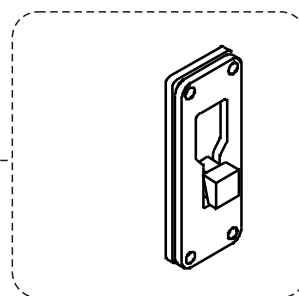
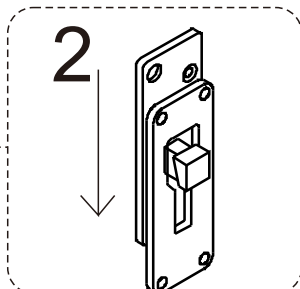
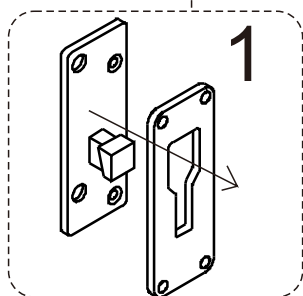
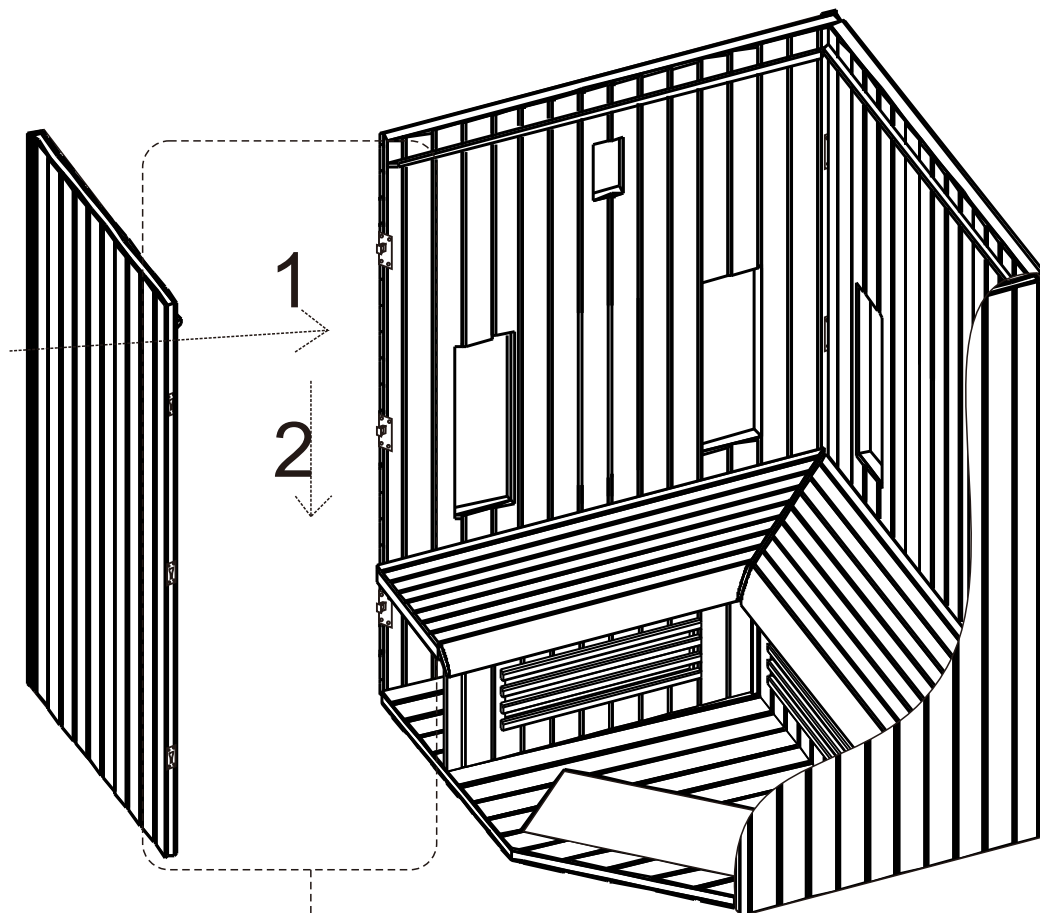
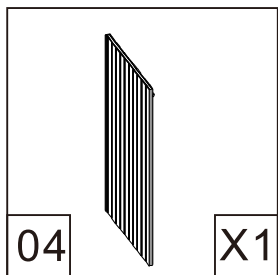

Etape 9



P12

Etape 10

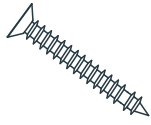
		
08	X4 16	ST 5x70
		X8 22
		X8

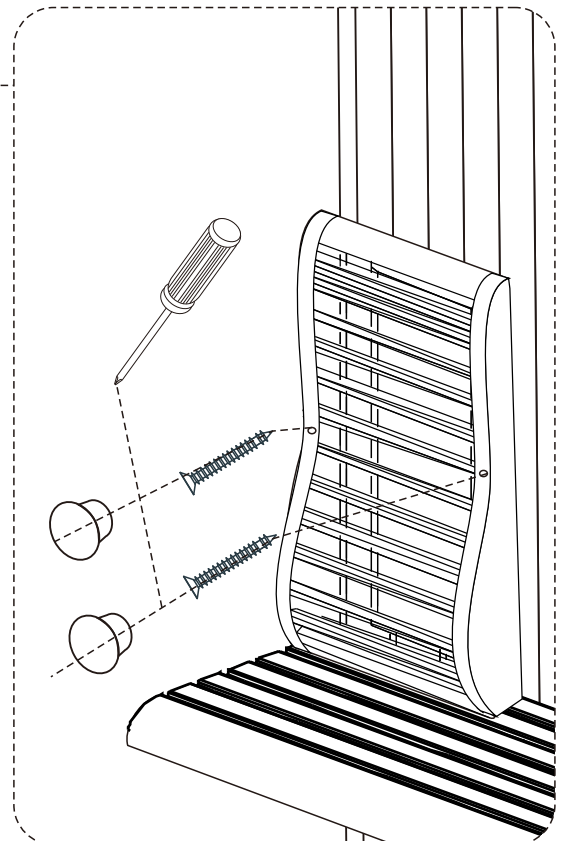
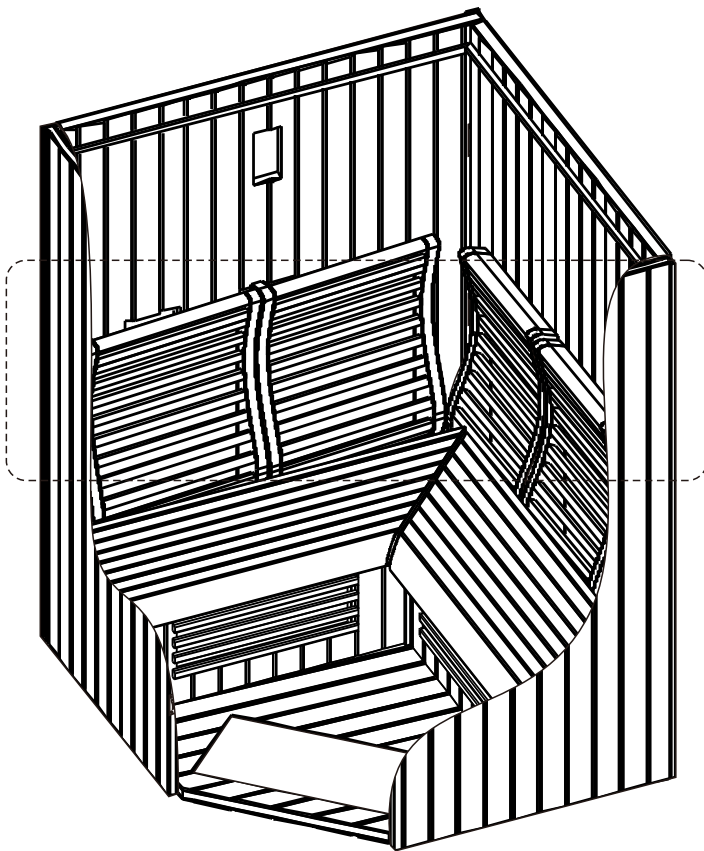
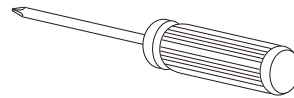

Etape 11

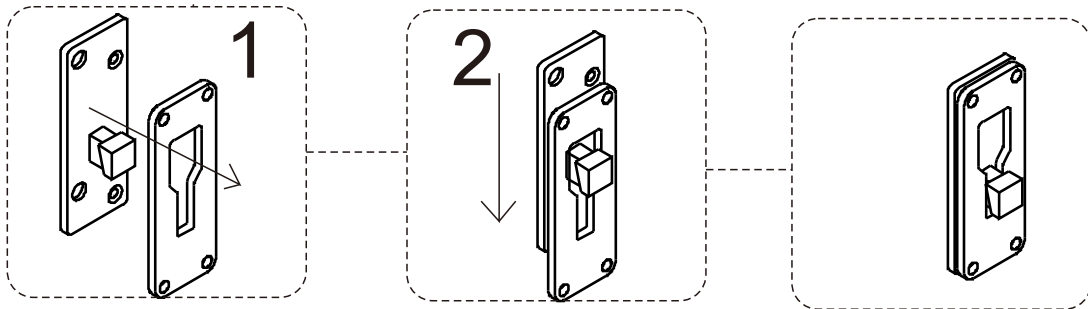
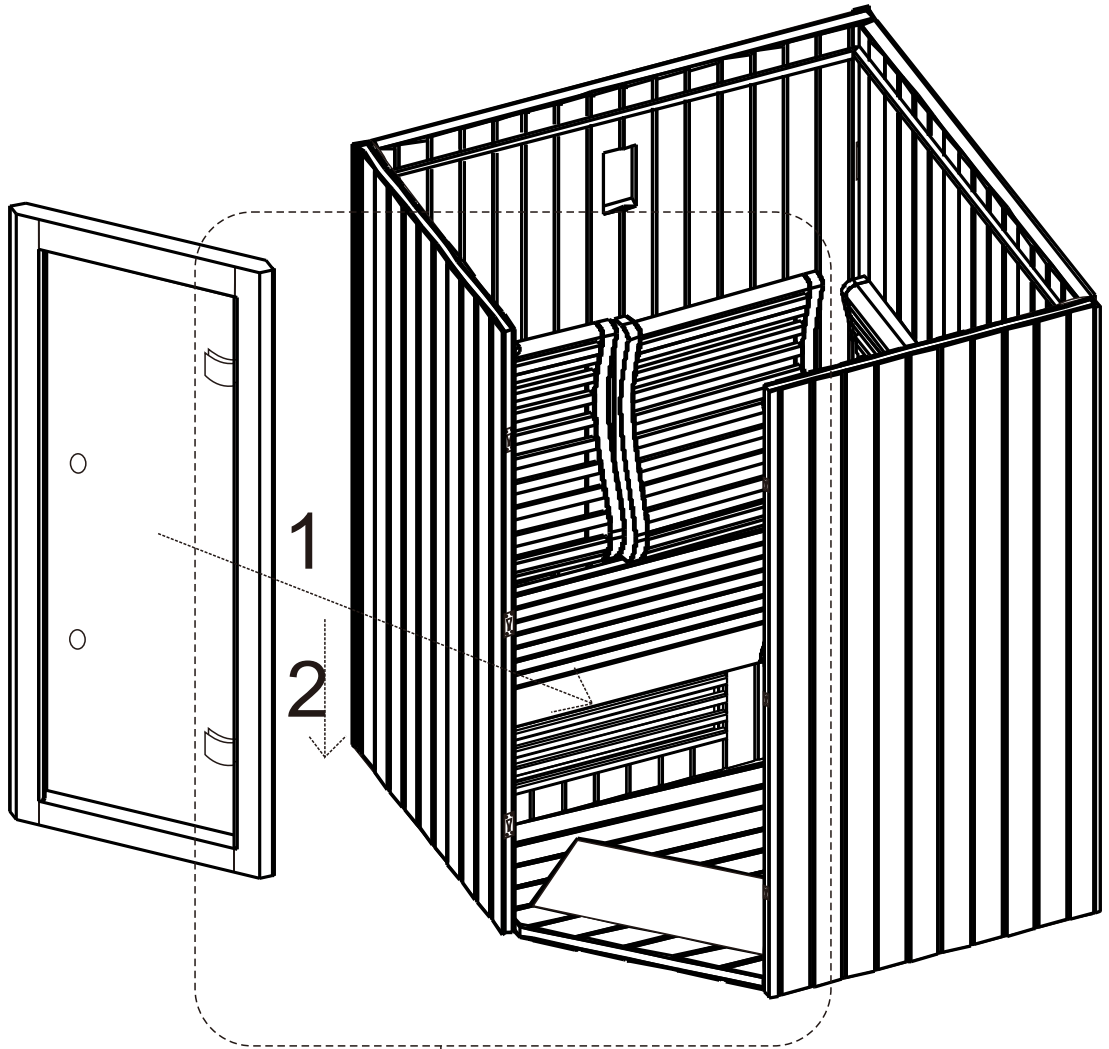
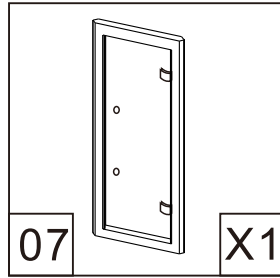

P14

Etape 12

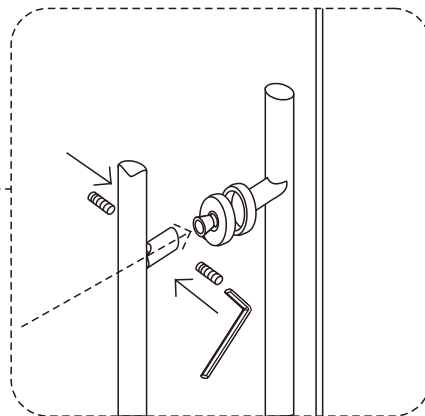
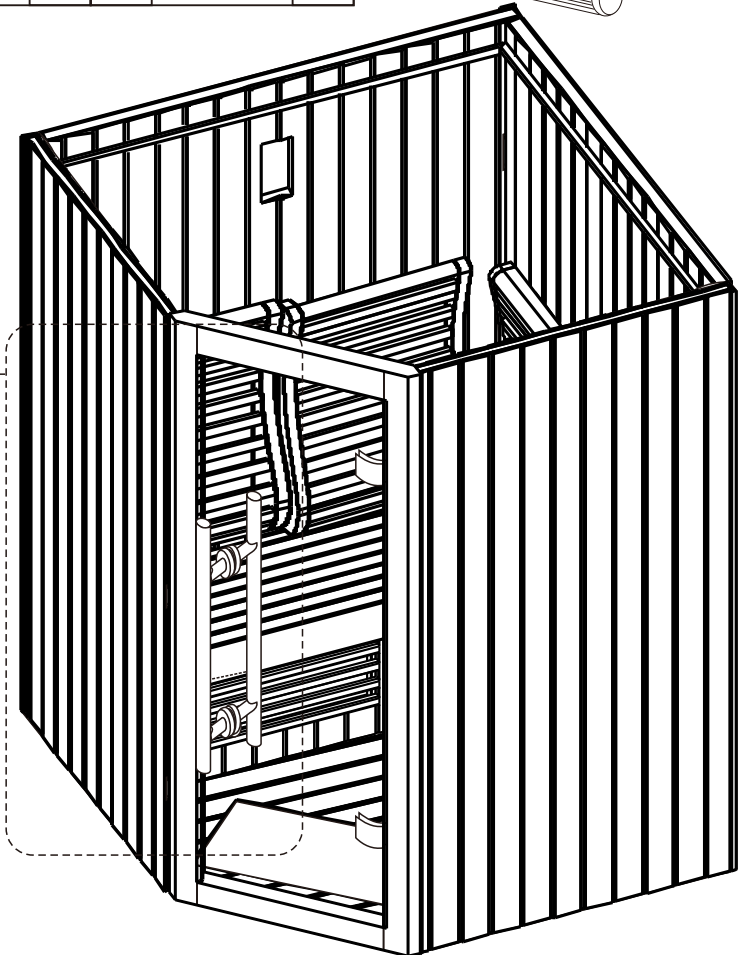
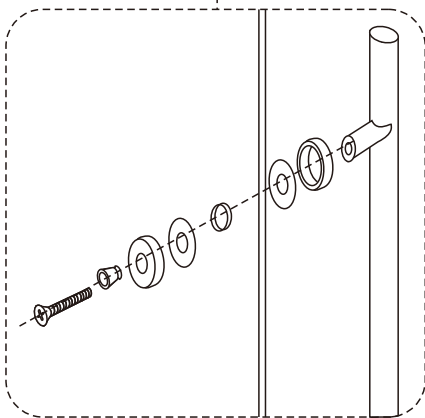
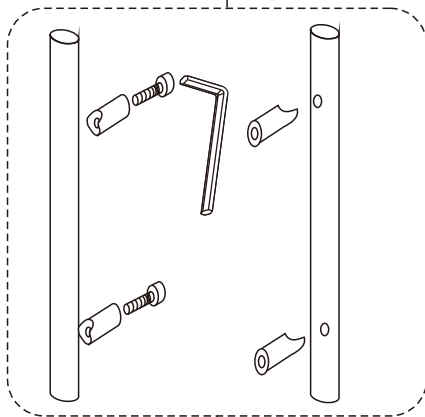
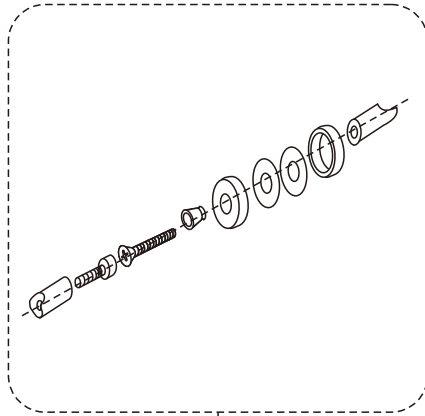
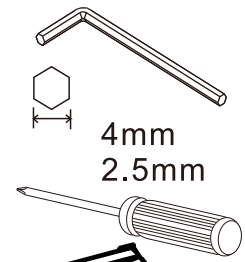
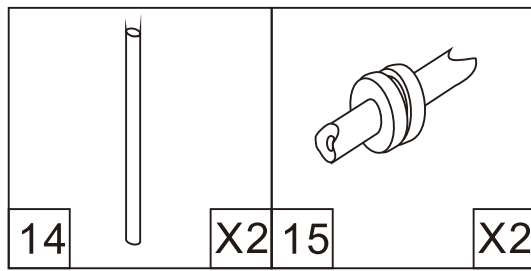

P15

Etape 13

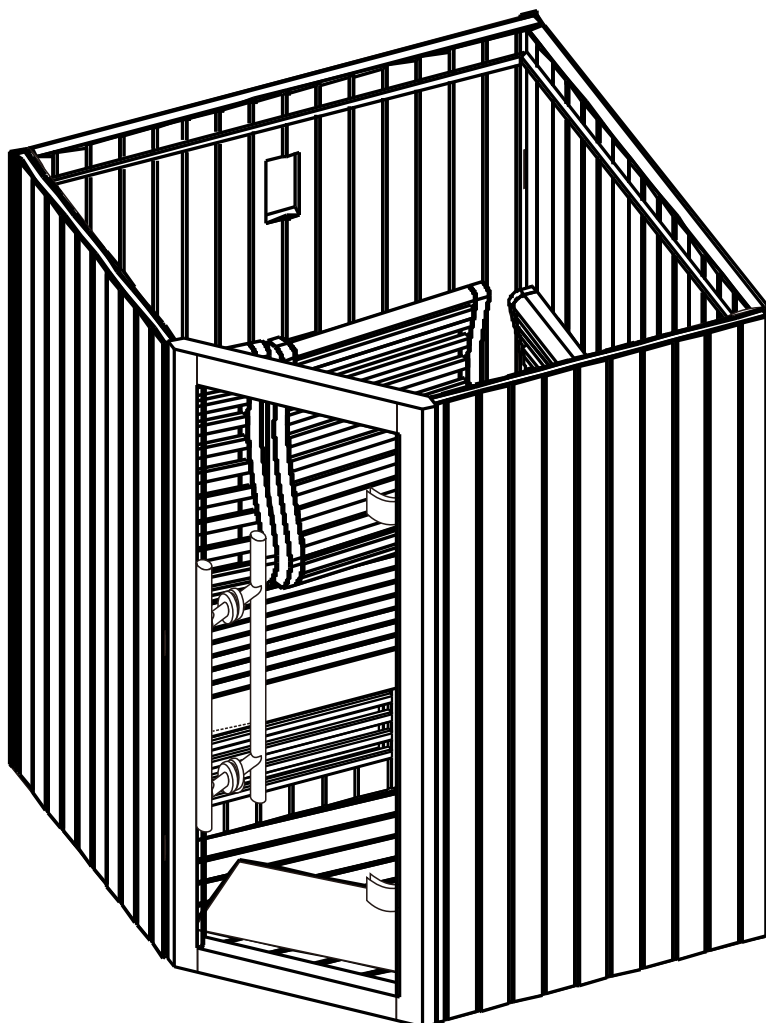
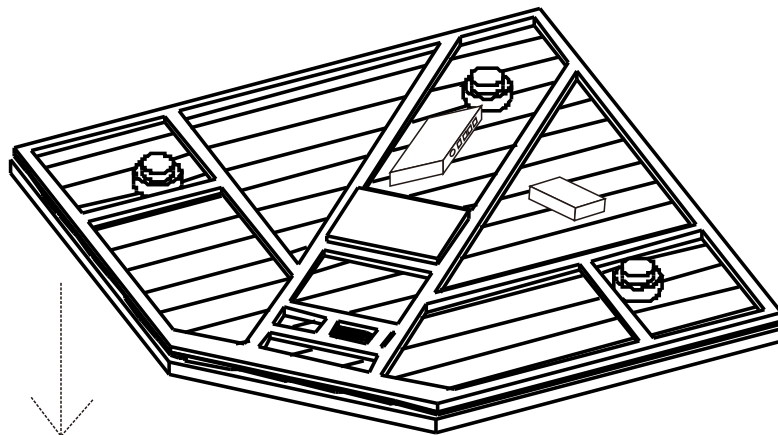
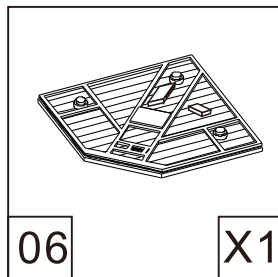

Etape 14

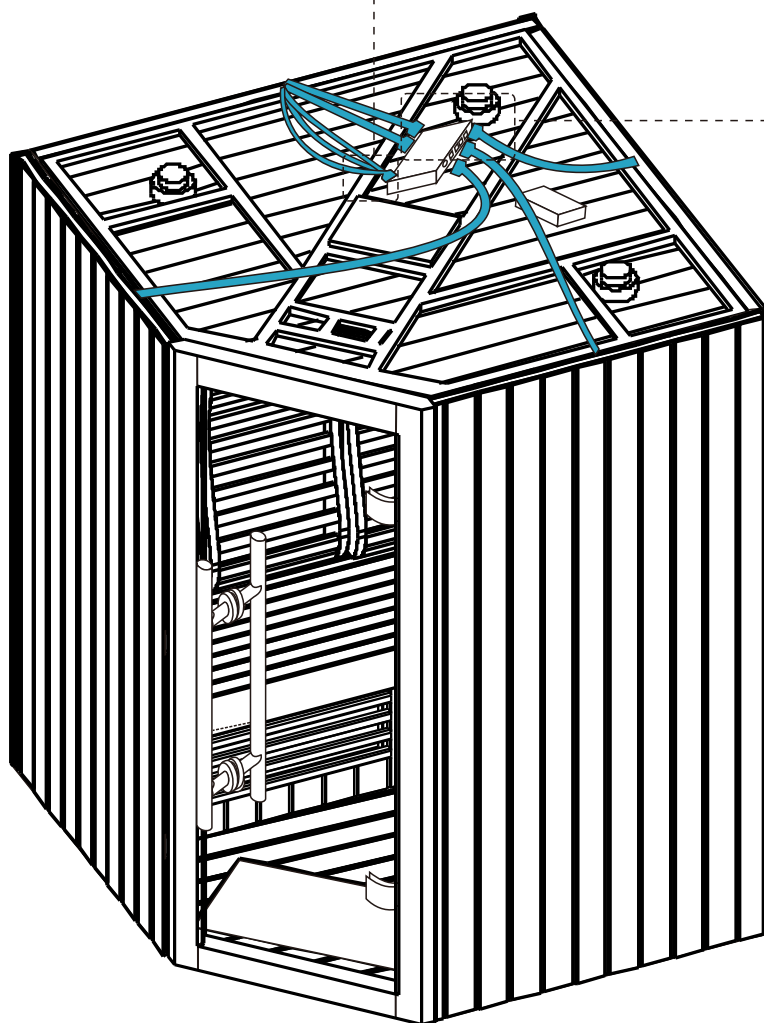
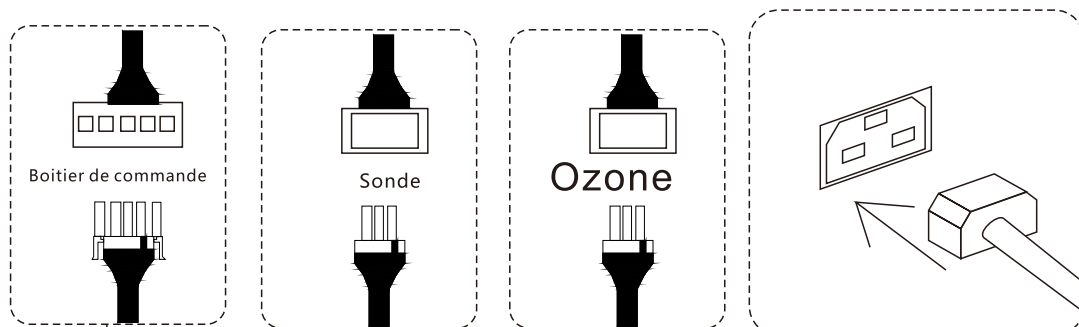

Etape 15

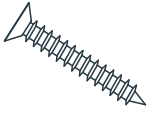

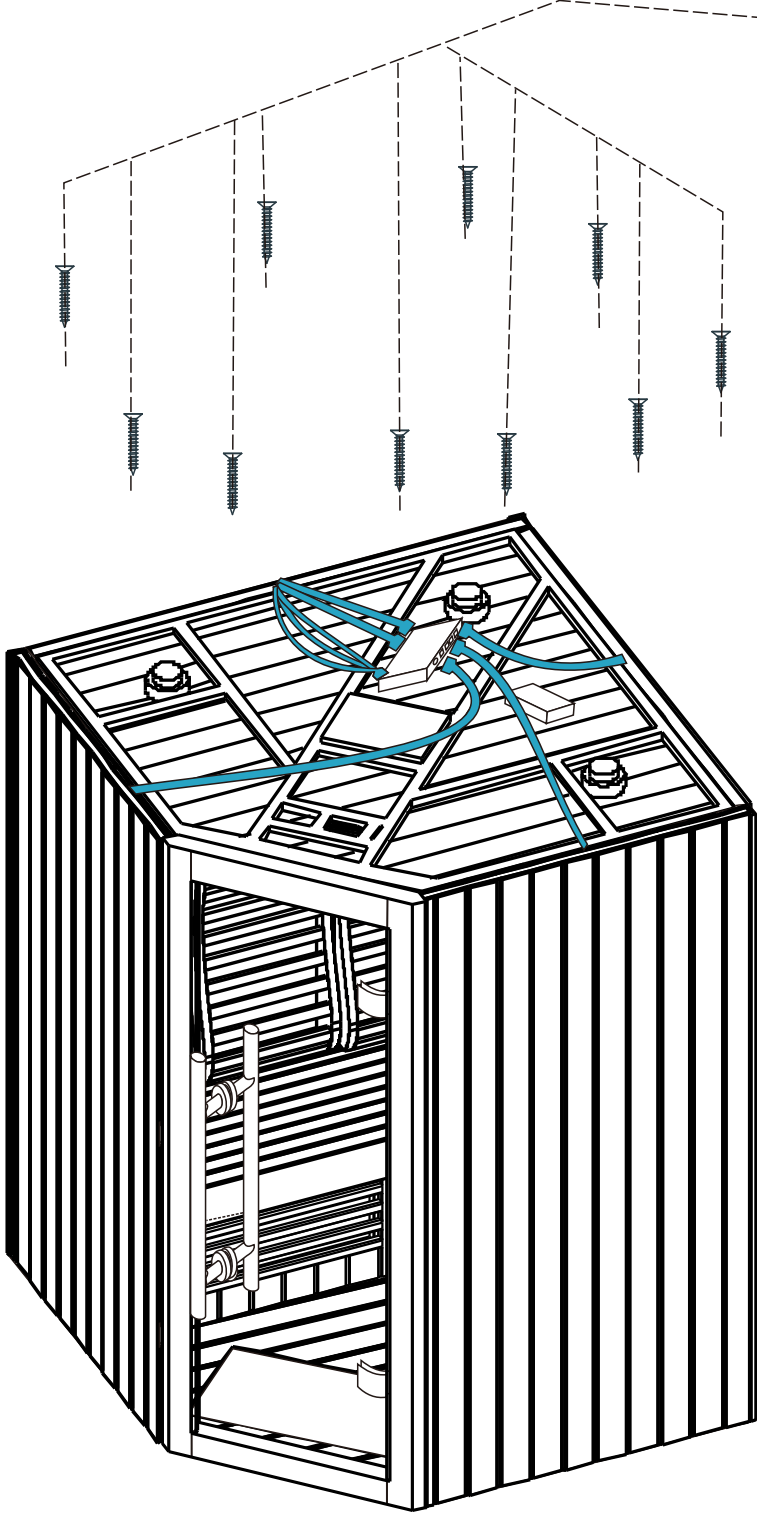
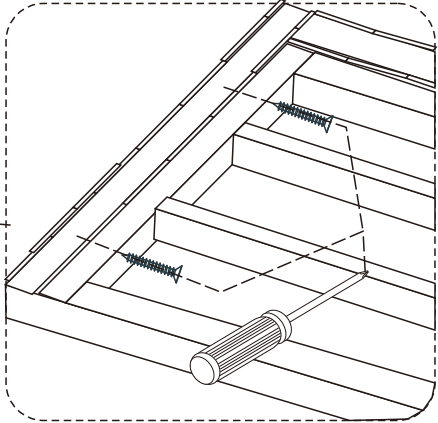

ST 5x60

21	X10
----	-----



P18

Etape 16

 ø8	 ø10	 ST 4x12			
19	X5	20	X5	24	X10

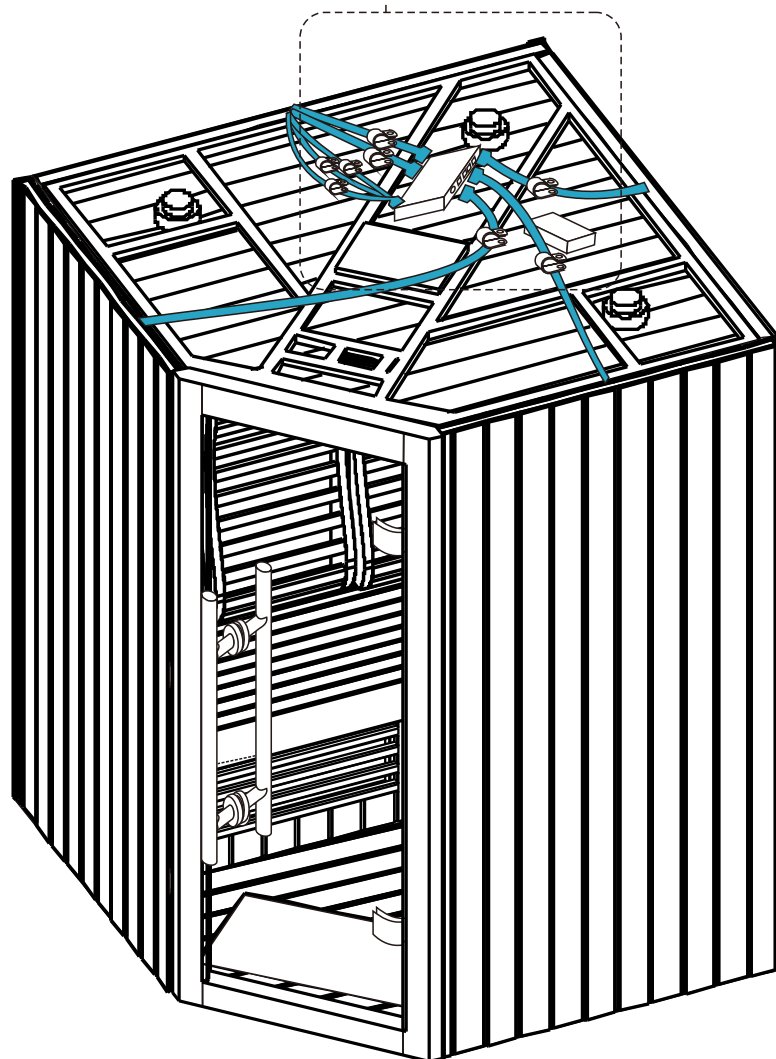
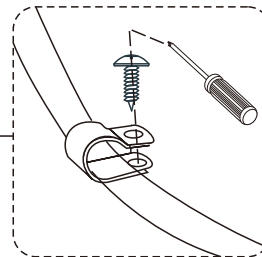
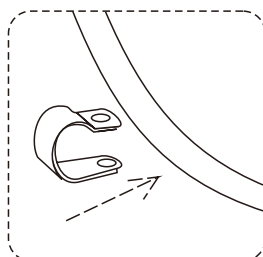
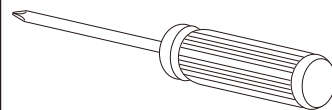

P19