

Boreal 150C

Notice d'installation



Modèle Boreal 150C

1500x1500x2000mm

Tension : AC220-240V







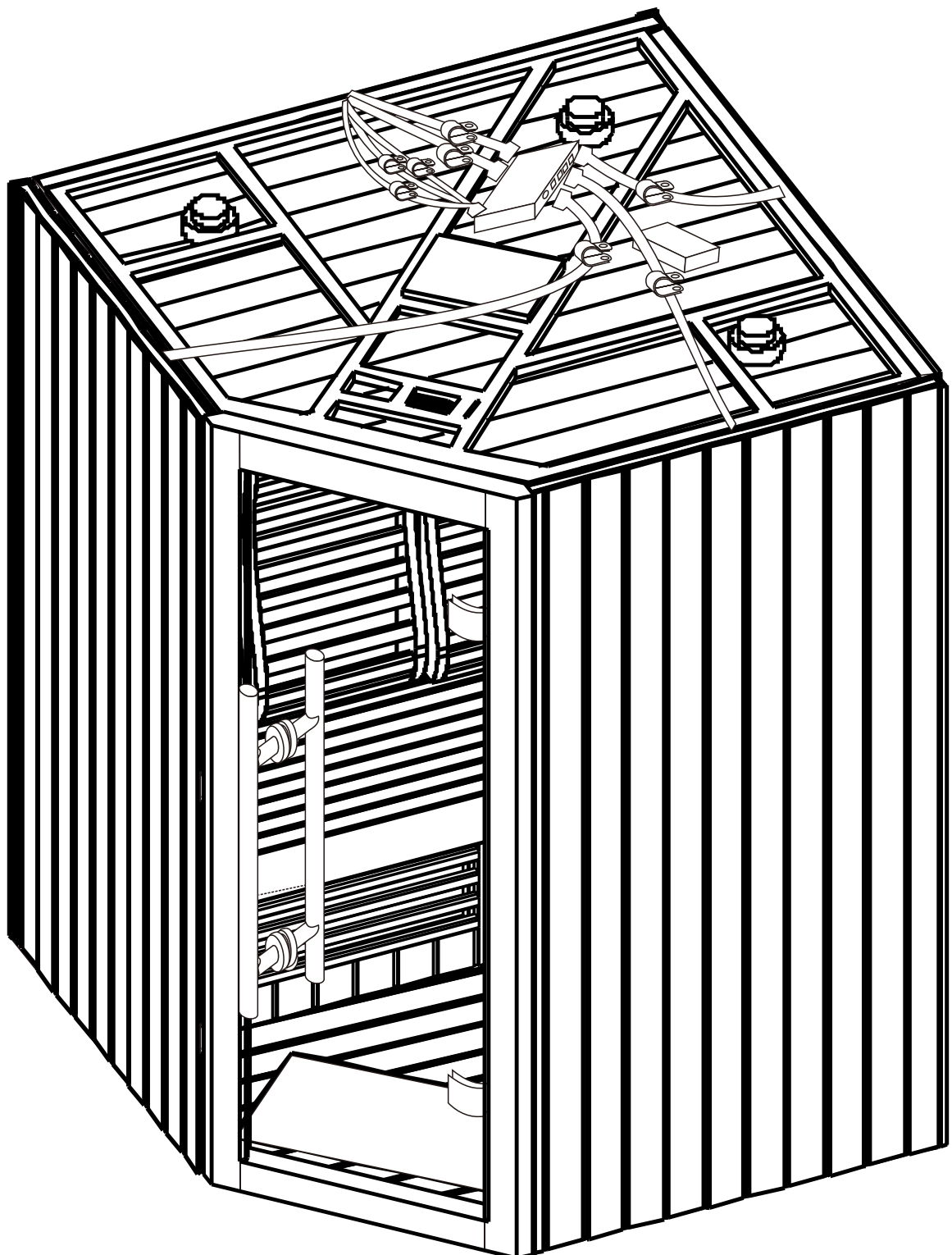

Puissance : 3270W

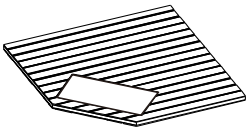
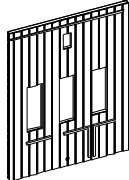
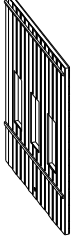
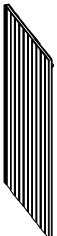
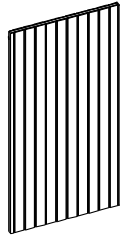
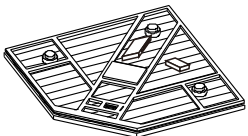
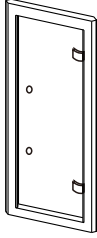
Courant : 14.8A

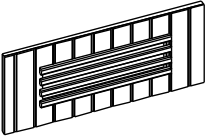
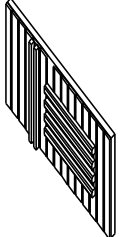
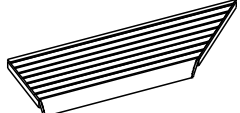
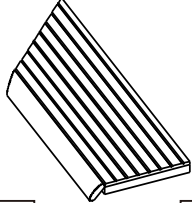
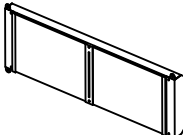
Fréquence nominale: 50/60HZ

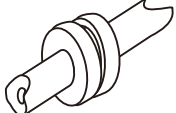
Résistance isolée : >20MΩ

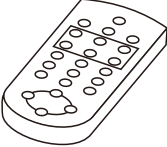

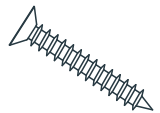
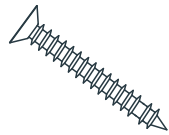
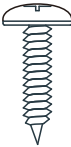
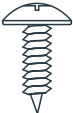
				
01	X102	X103	X104	X105
				
06	X107	X108	X609	X110
				
11	X112	X113	X214	X215
				
16	X1217	X818	X119	X1020
				
ST 5x60	ST 5x70	ST 4x18	ST 4x12	
21	X1022	X1223	X824	X15

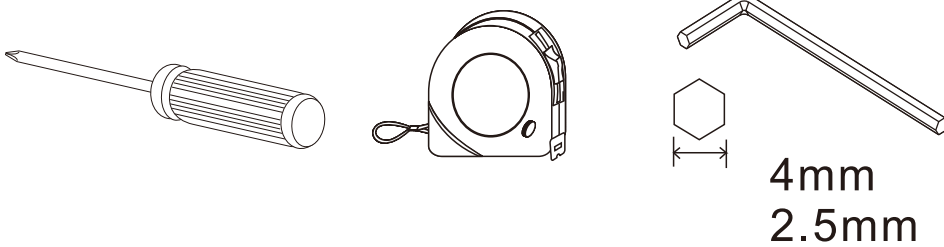

P1

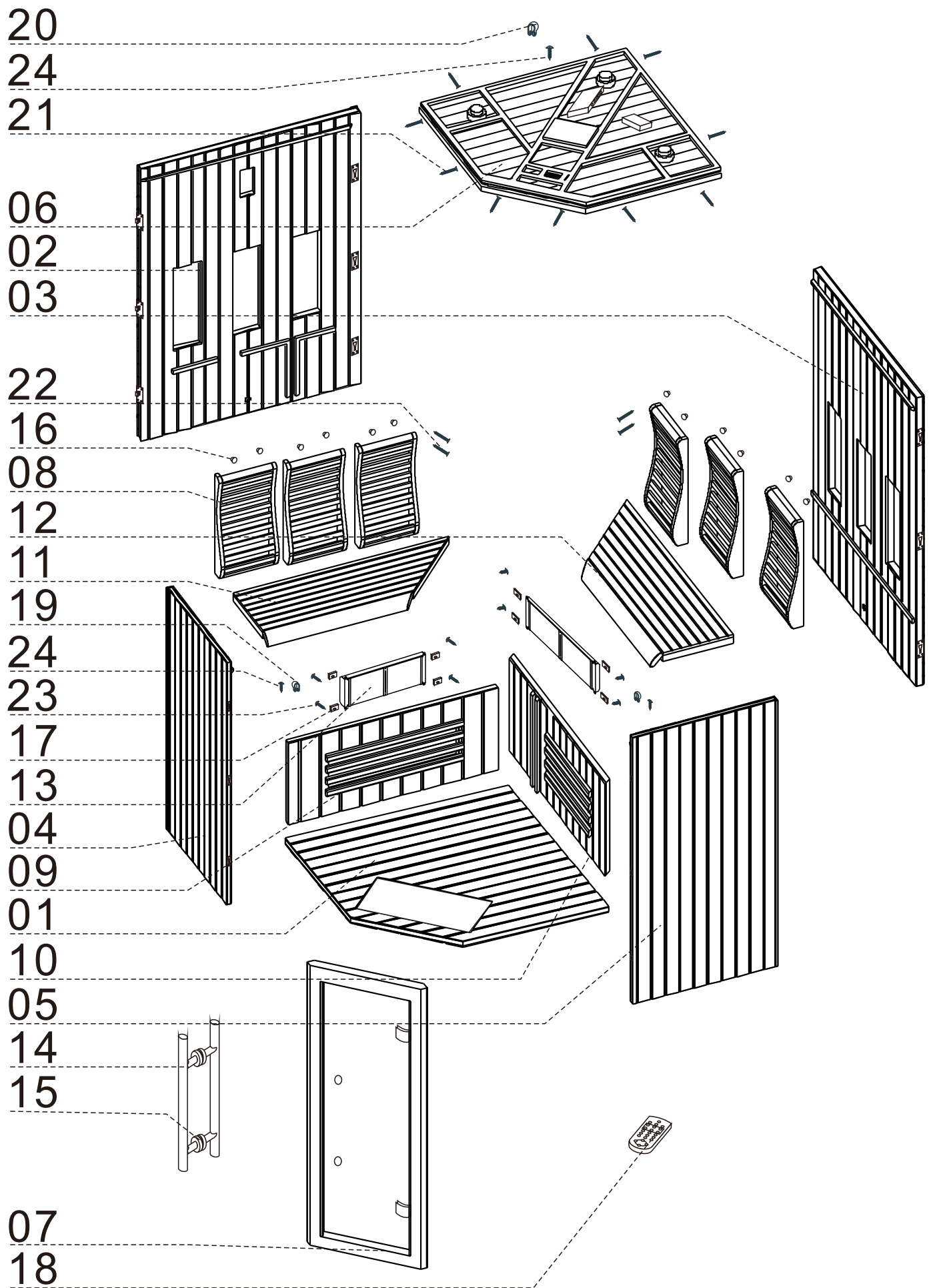

Etape 1

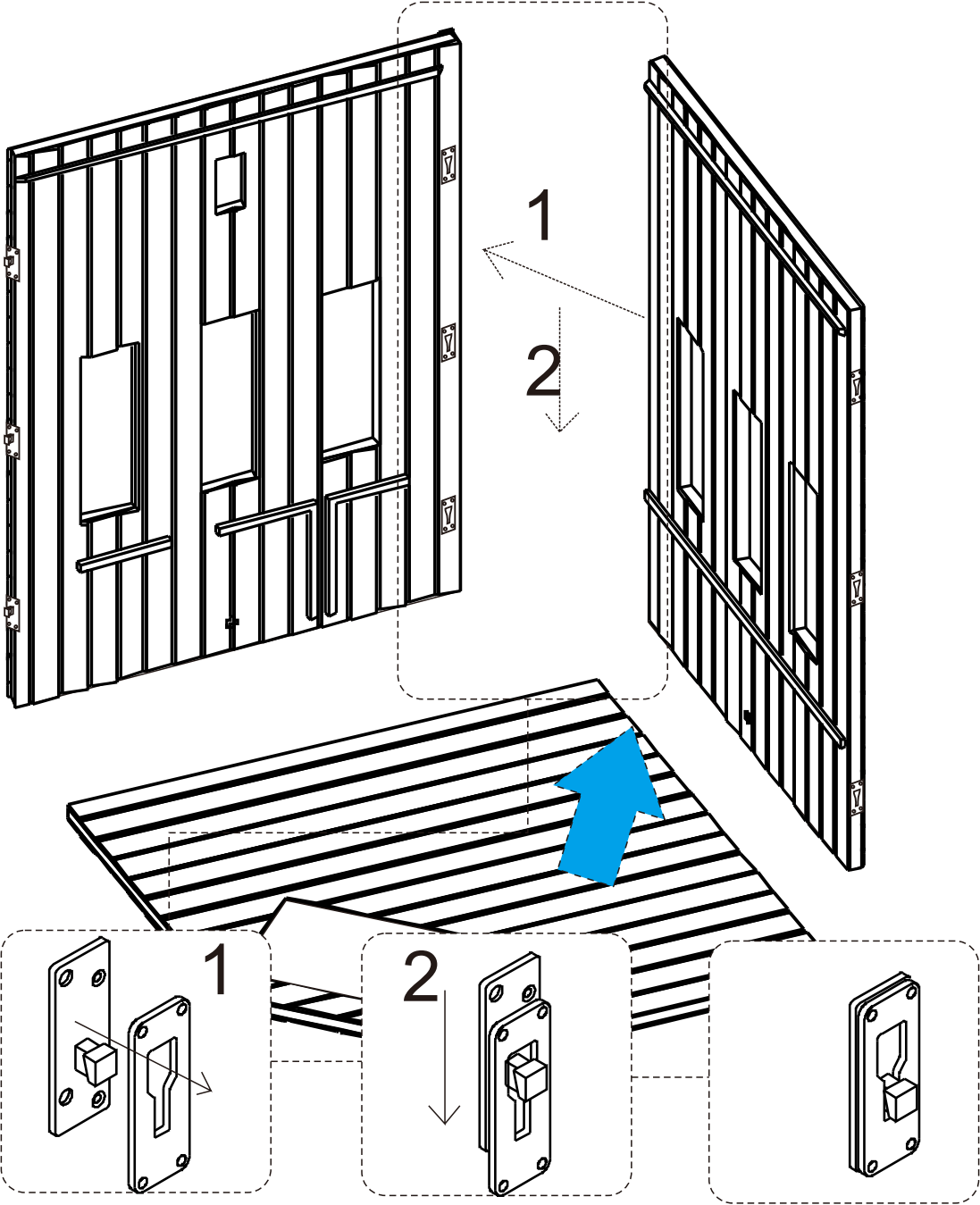
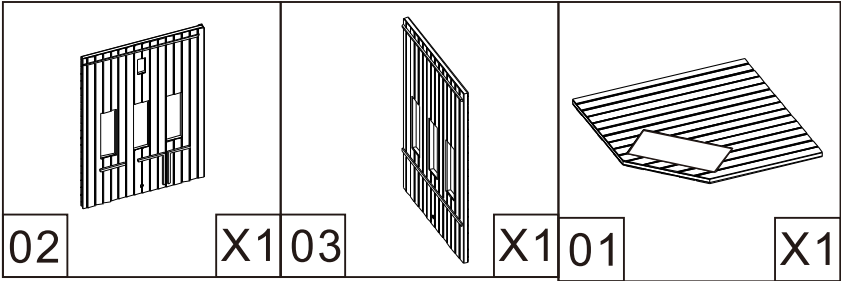

Etape 2

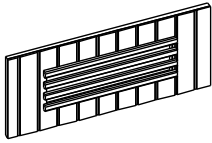
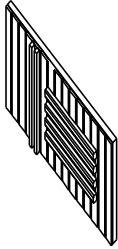
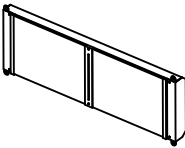
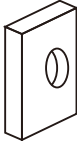
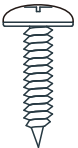
					
09	X1 10	X1 13	X2 17	X8 23	X8

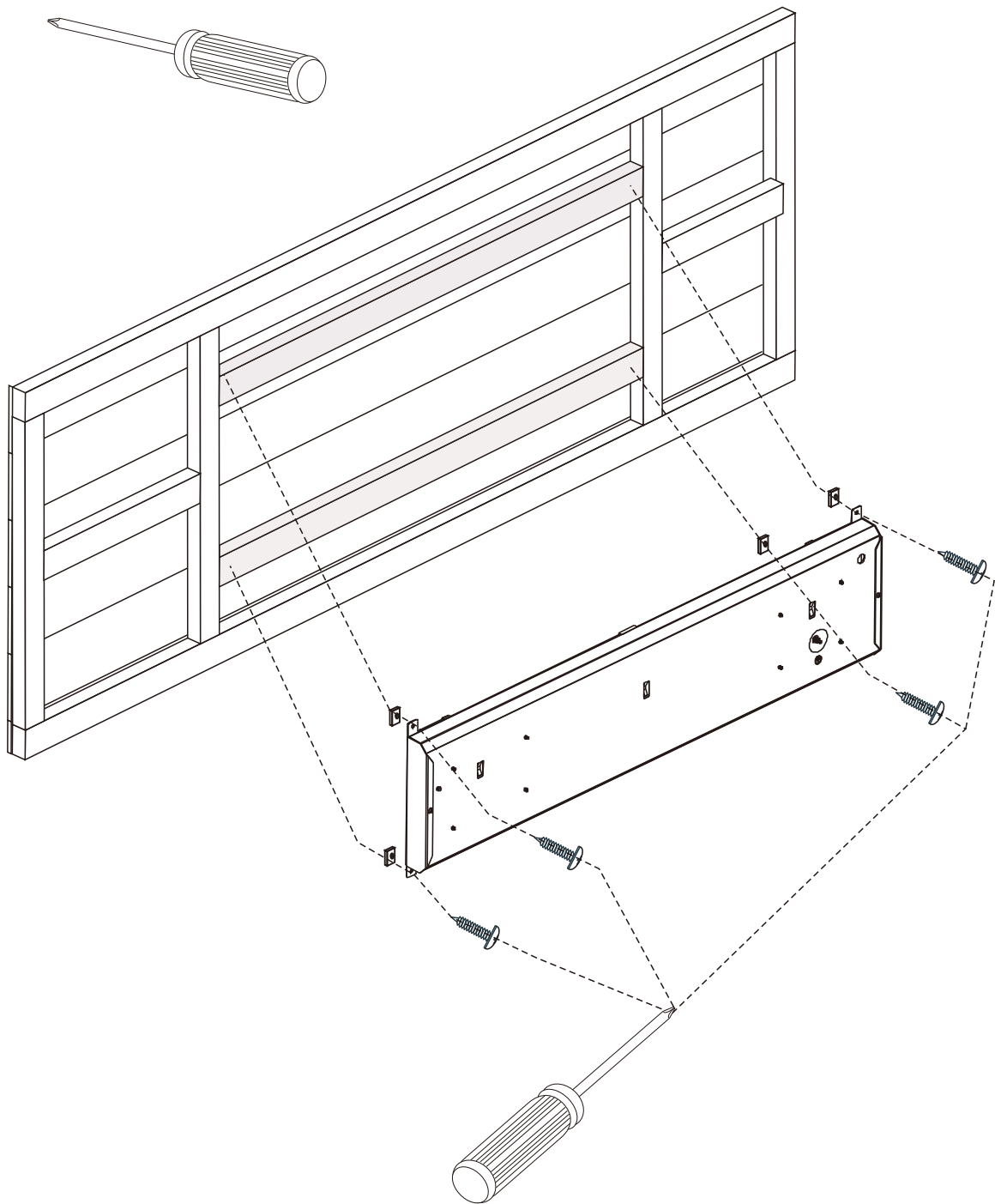

Etape 3

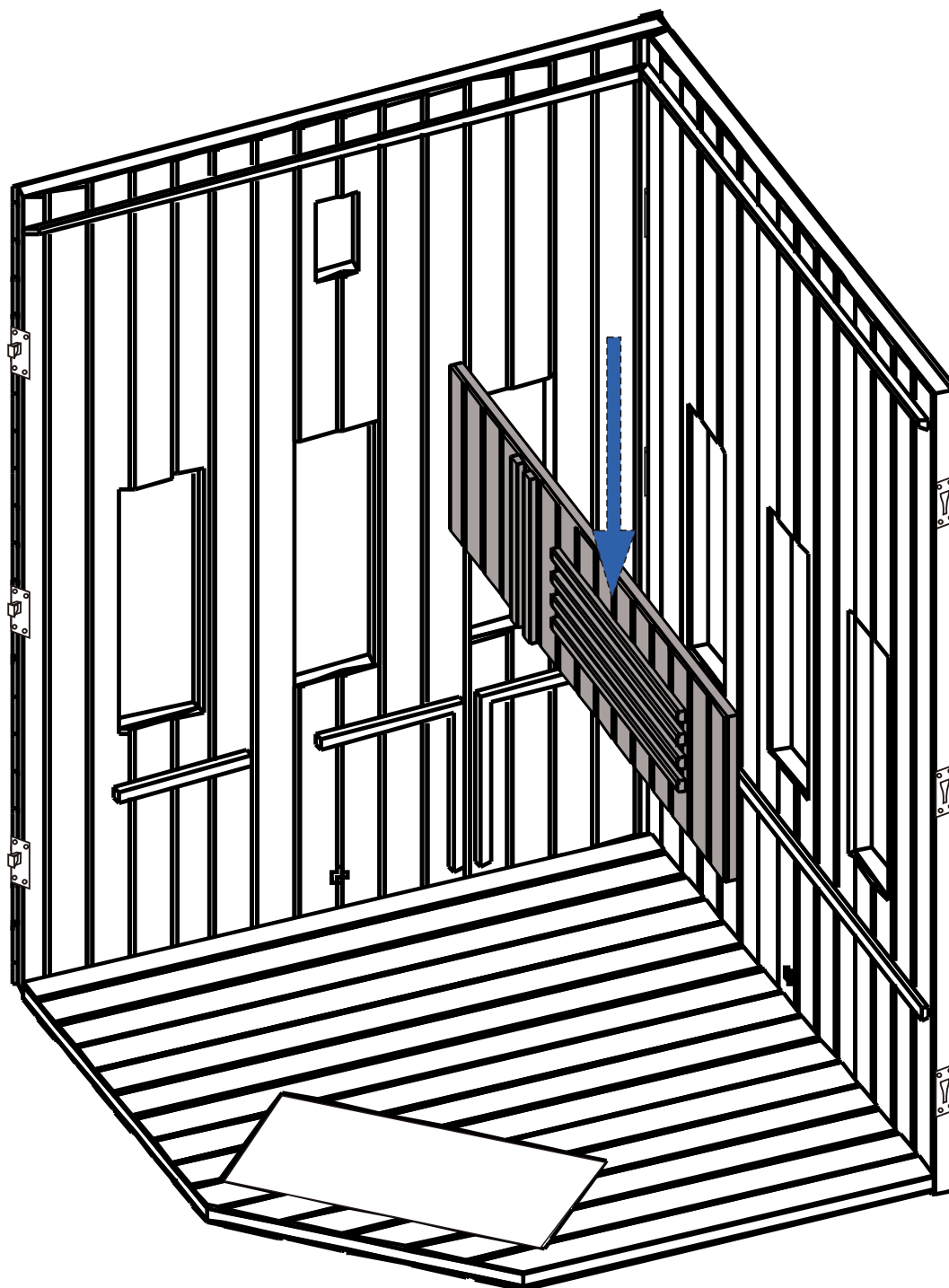
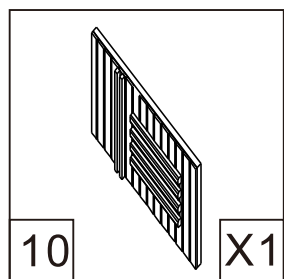

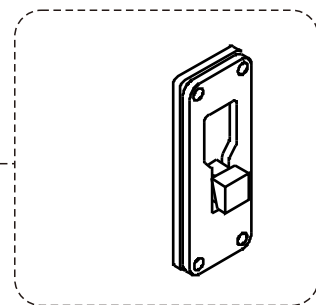
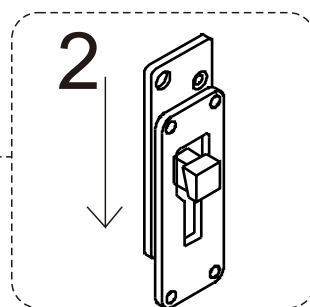
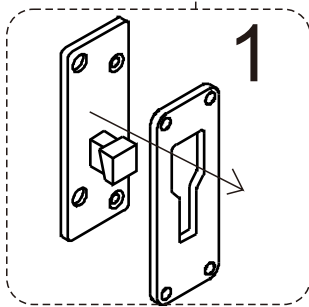
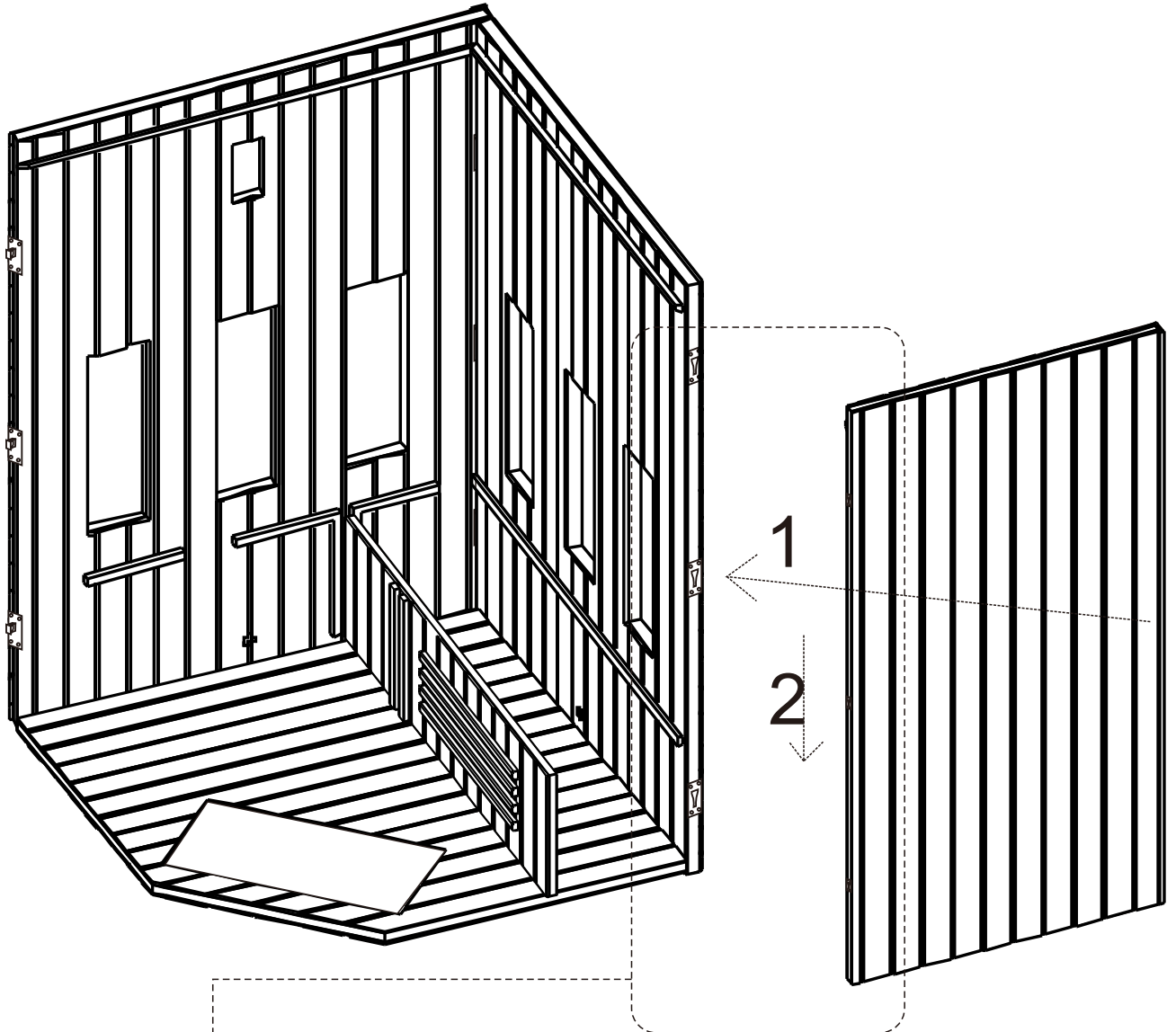
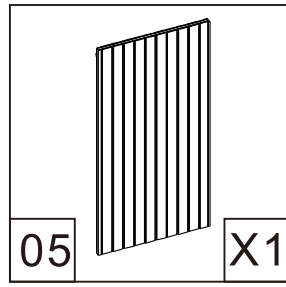

Etape 4

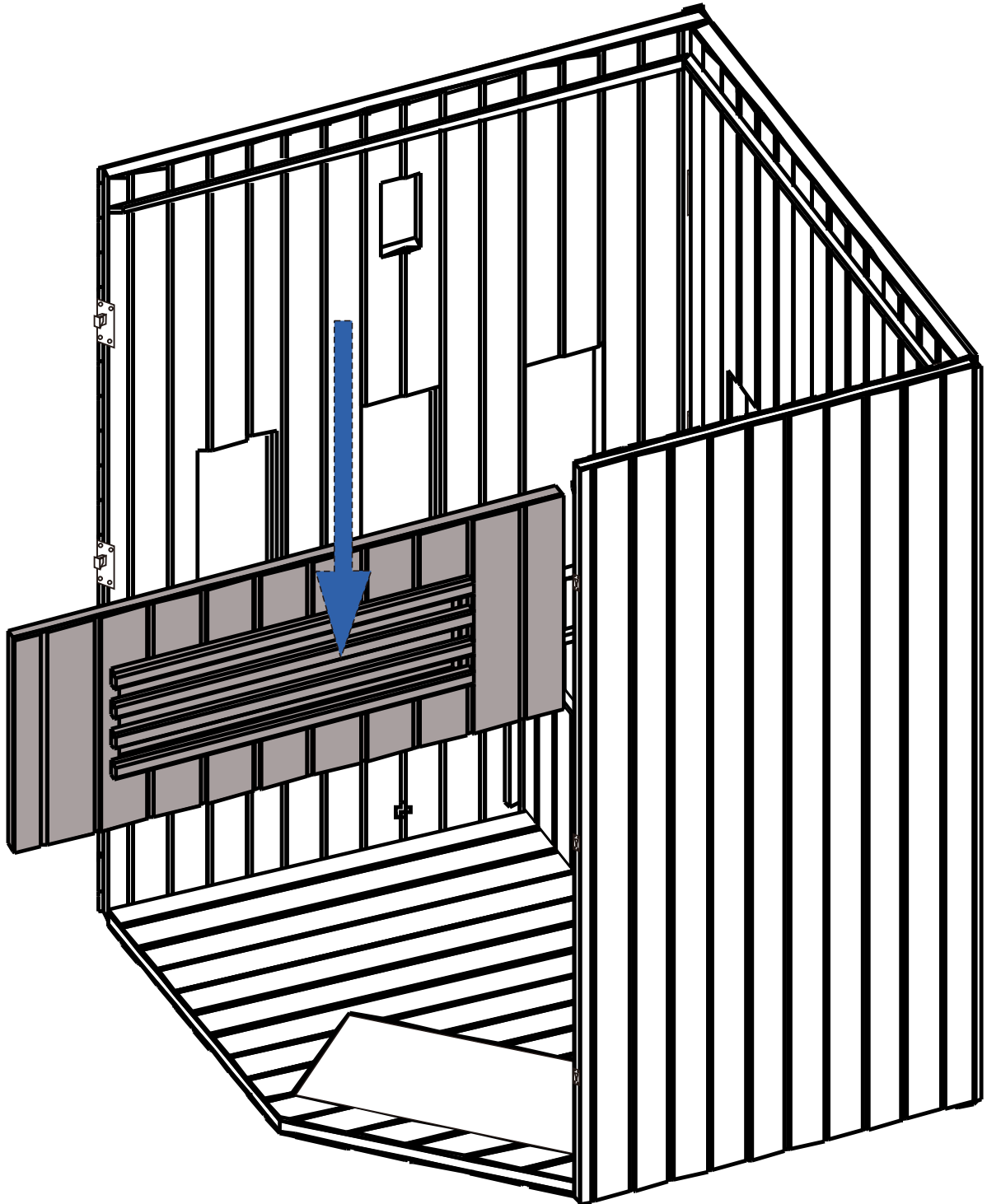
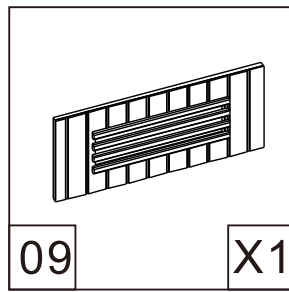

Etape 5



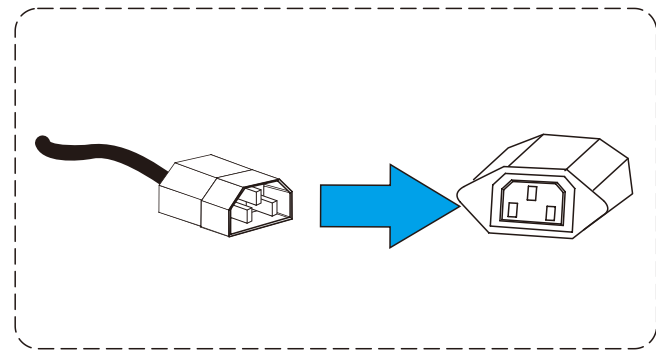
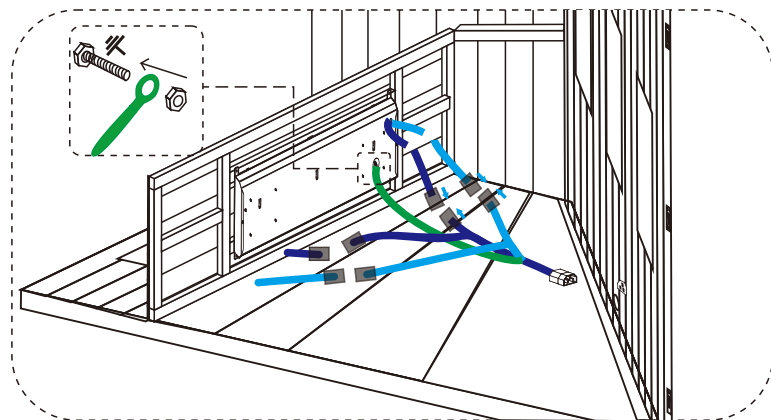
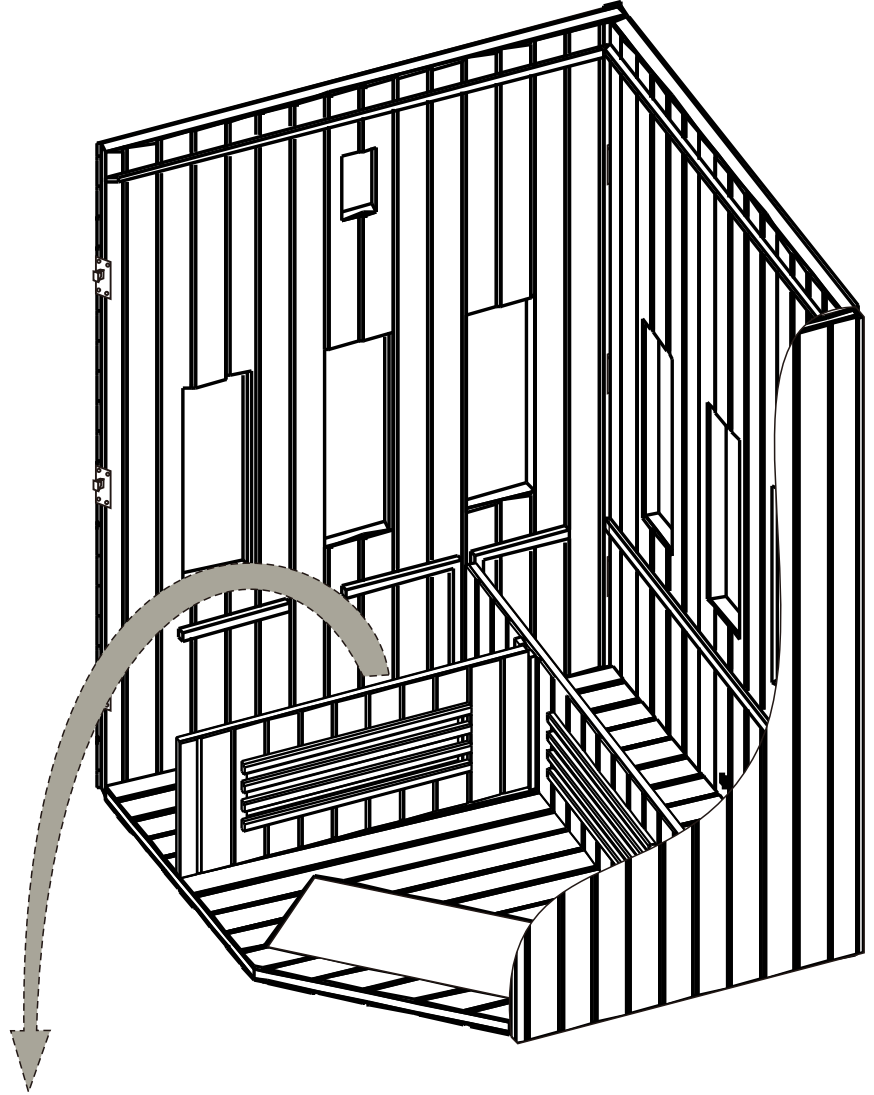
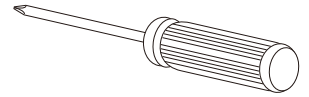

Etape 6

 ø8	 ST 4x12		
19	X3	24	X3



Etape 7

 ø8	 ST 4x12		
19	X2	24	X2

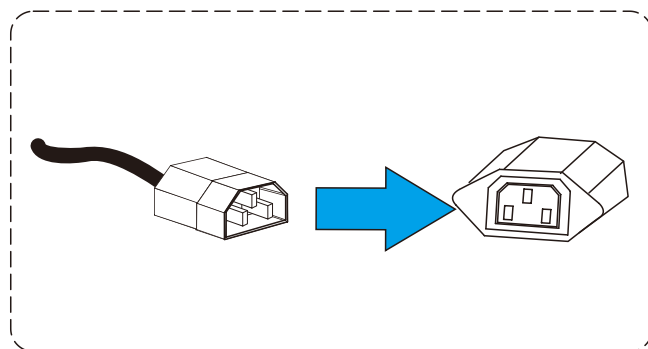
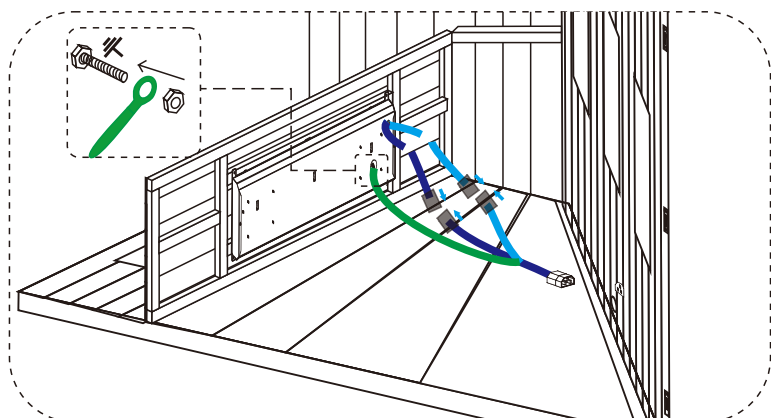
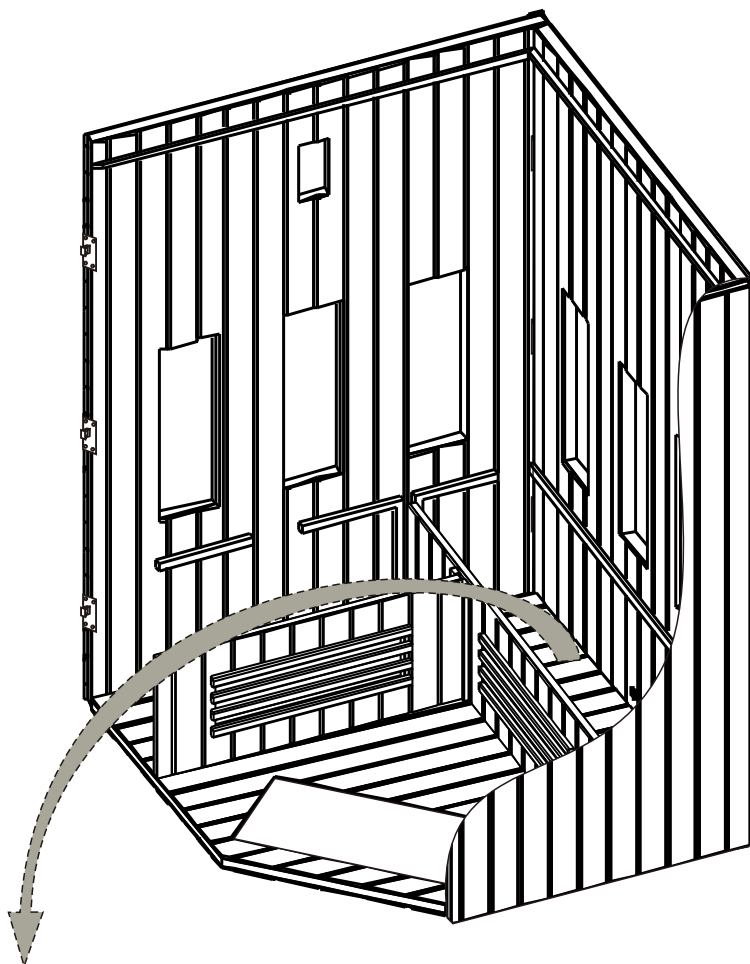
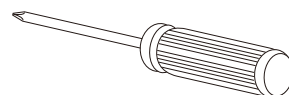

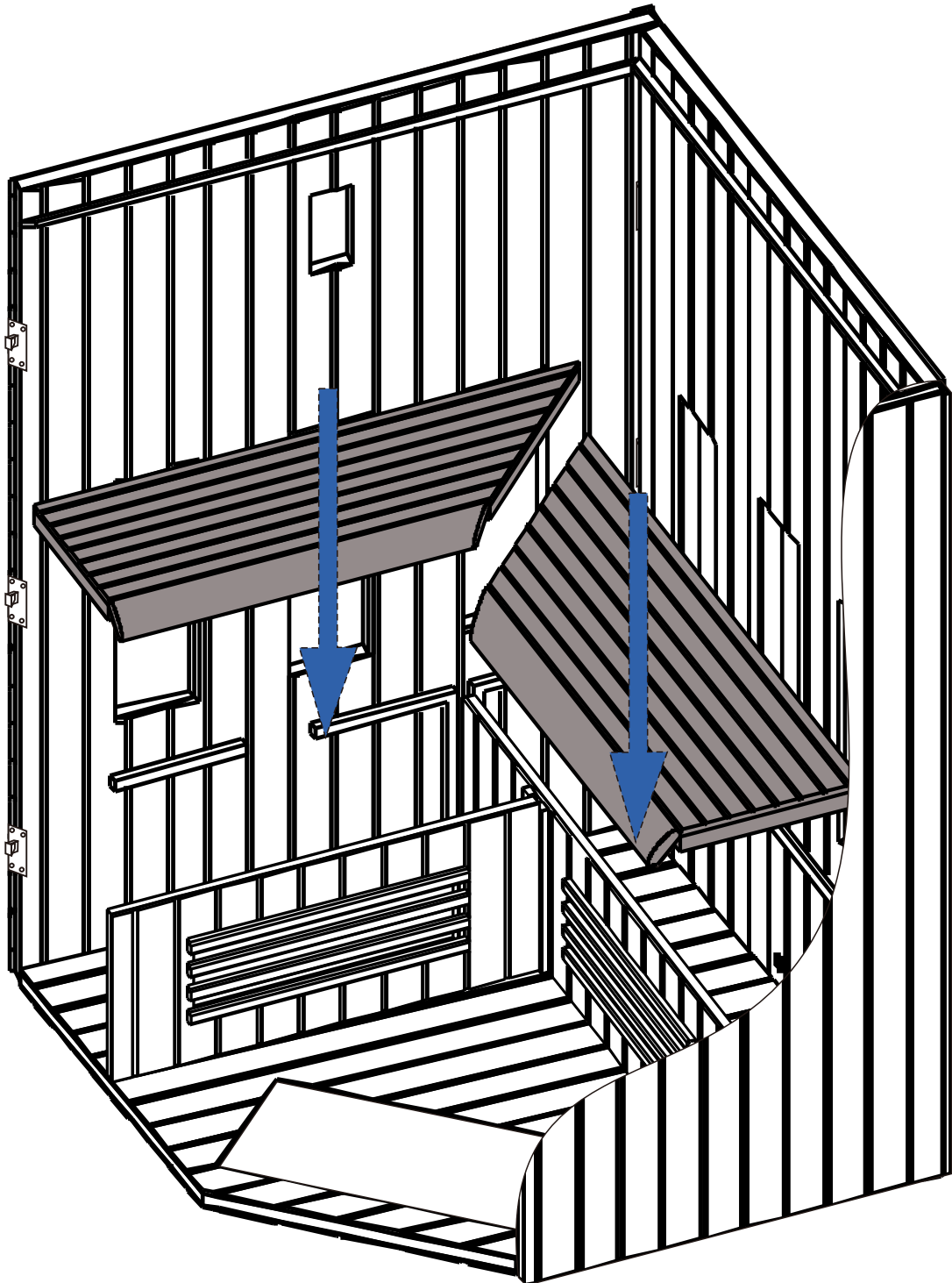
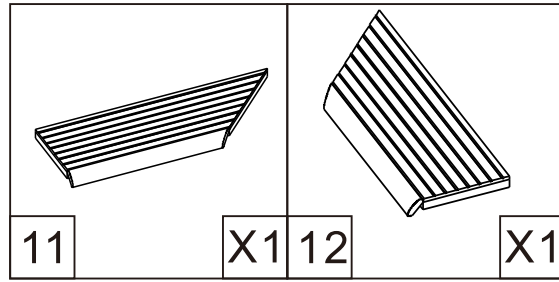

Etape 8

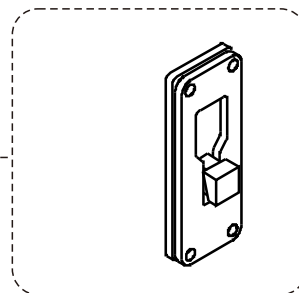
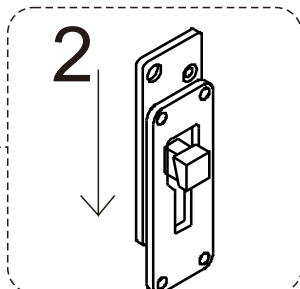
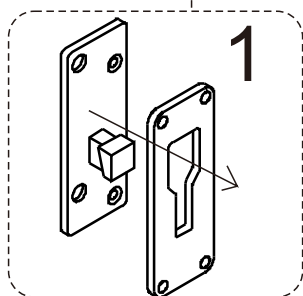
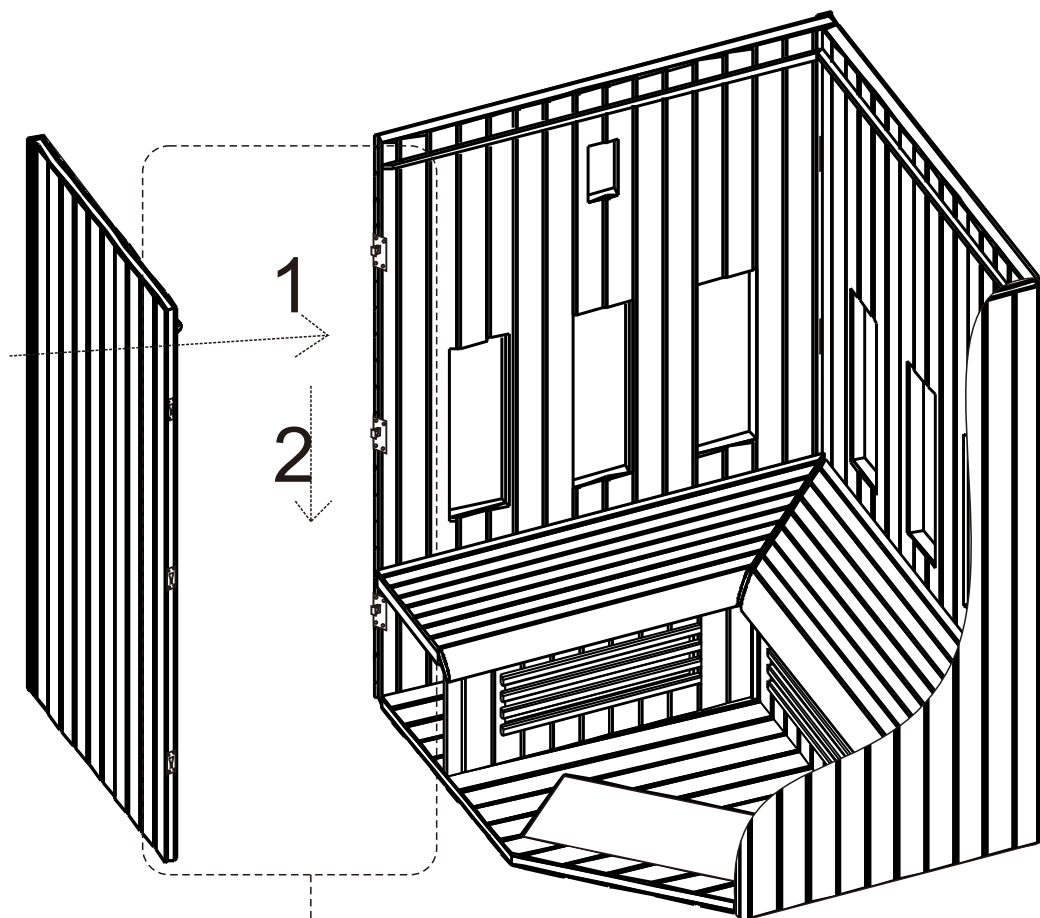
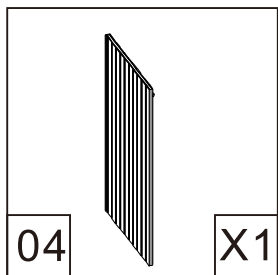

Etape 9

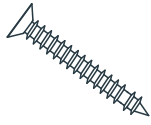

Etape 10

		 ST 5x70	
08	X6 16	X12 22	X12

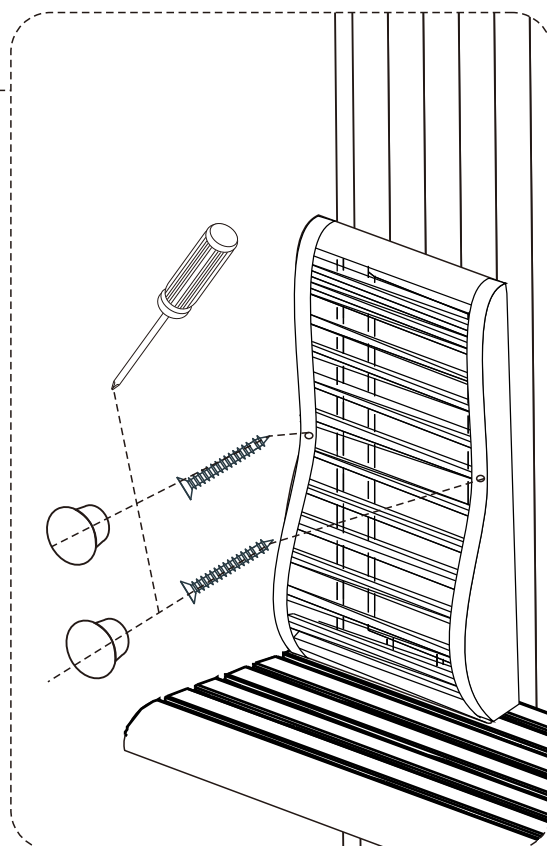
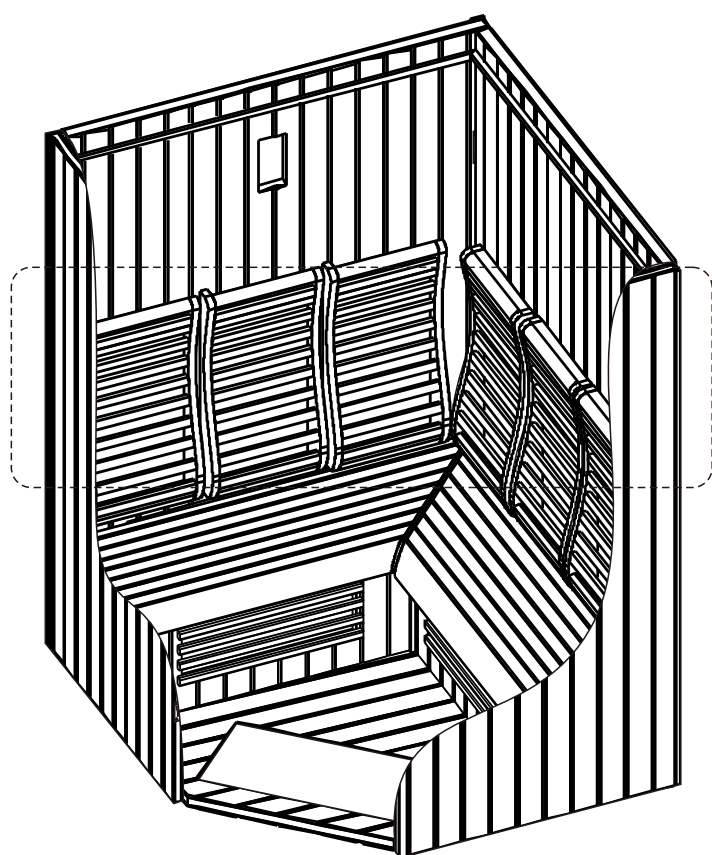
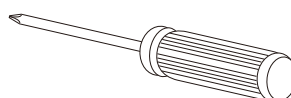

Etape 11

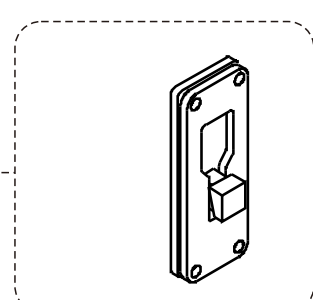
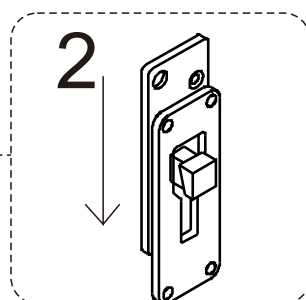
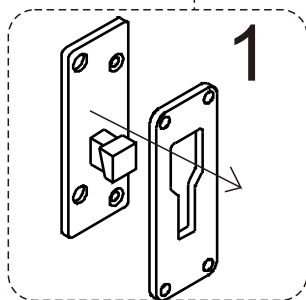
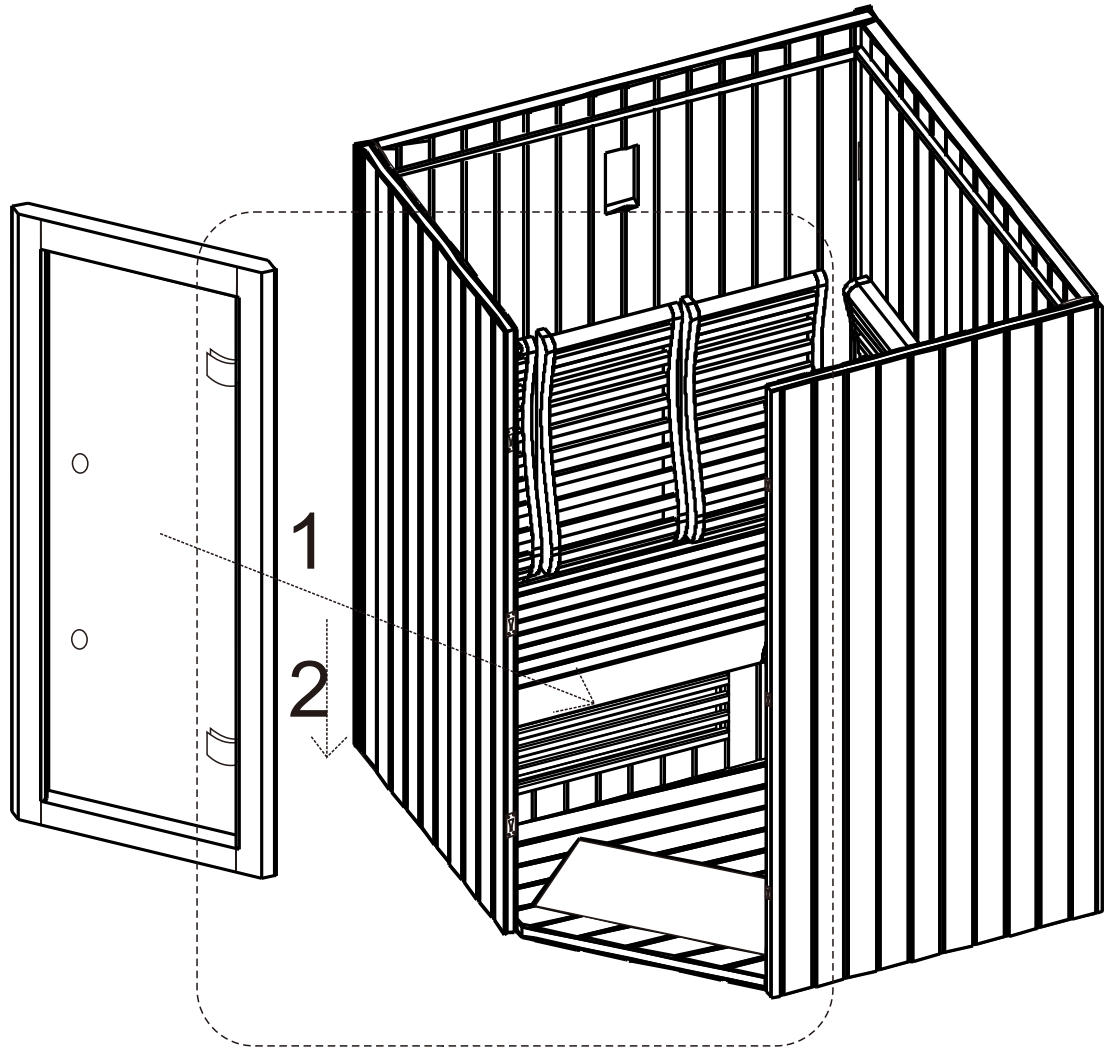
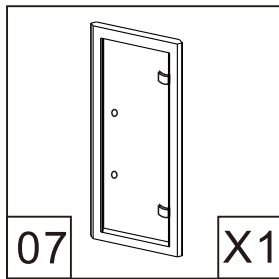

Etape 12

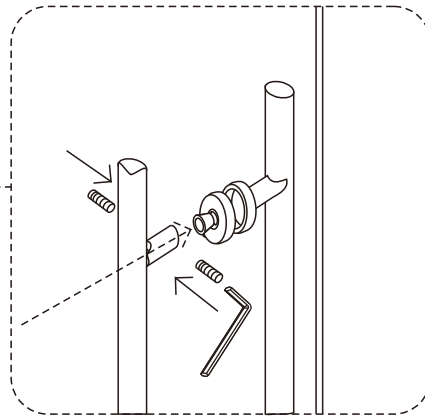
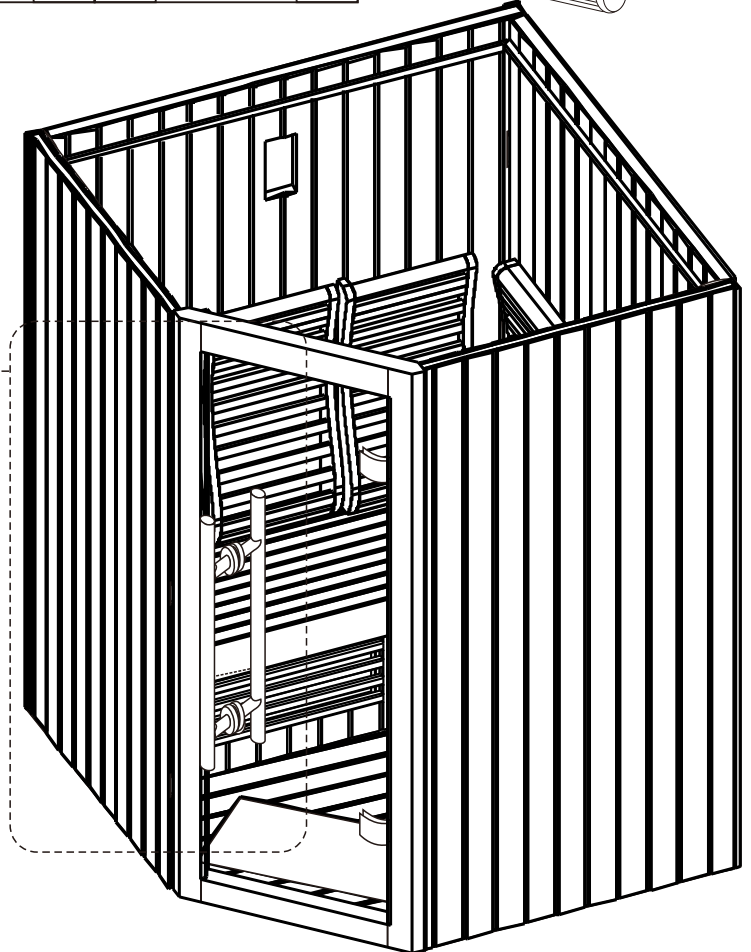
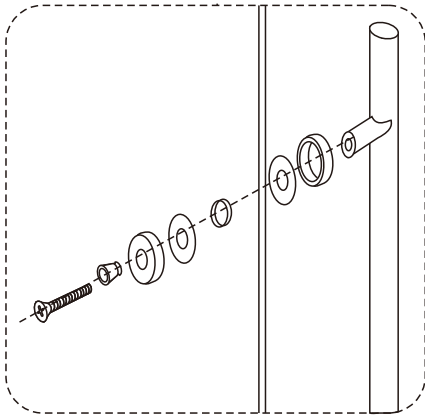
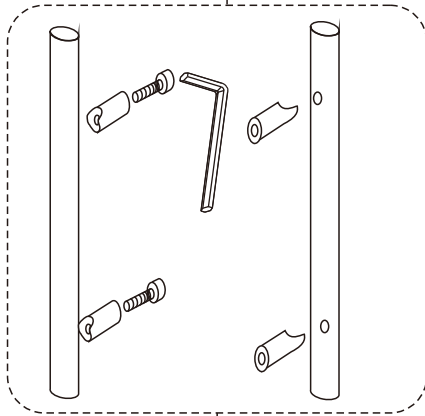
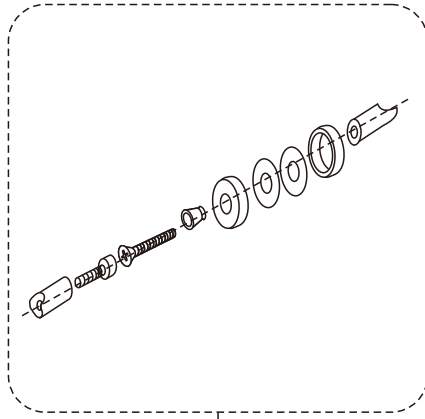
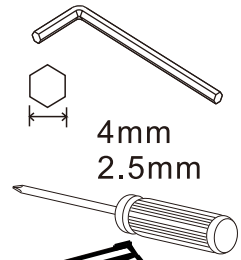
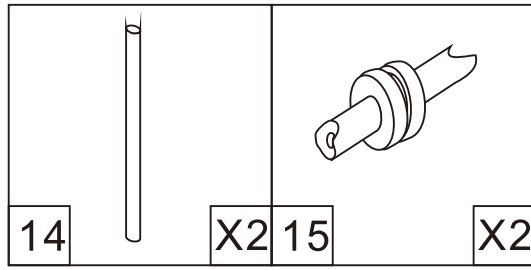

Etape 13

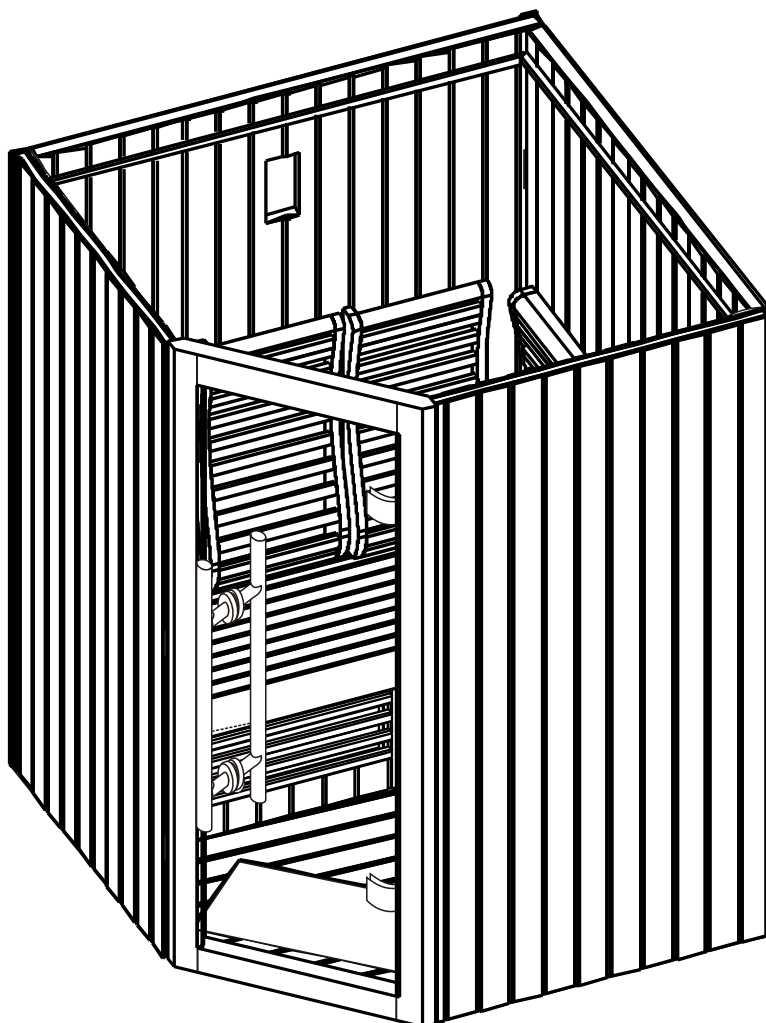
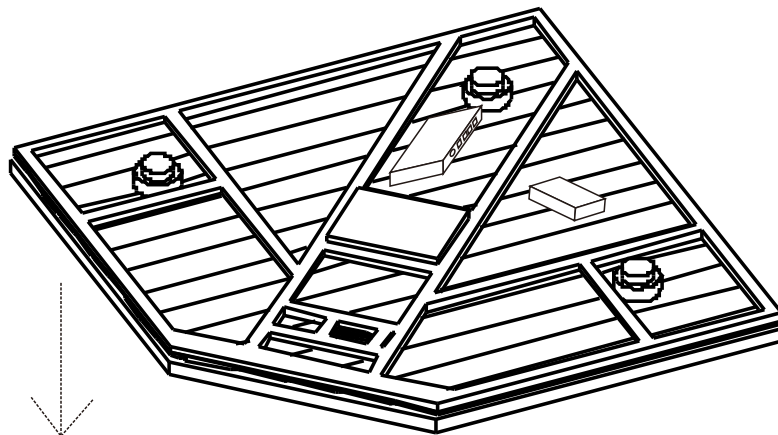
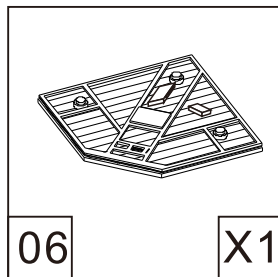

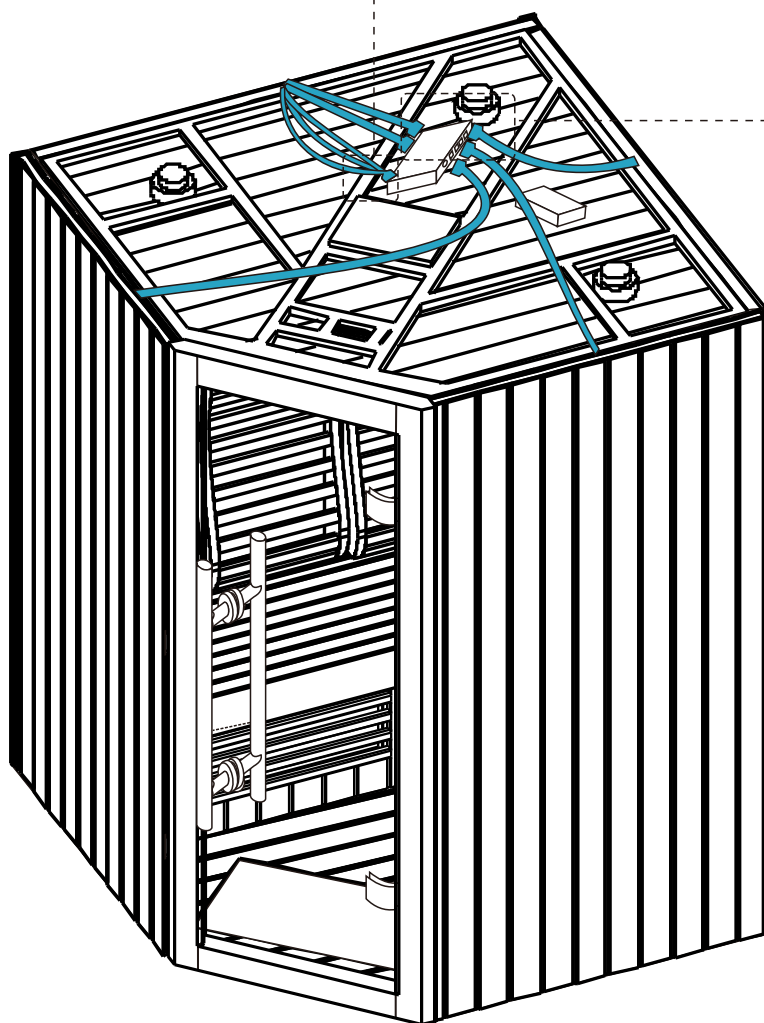
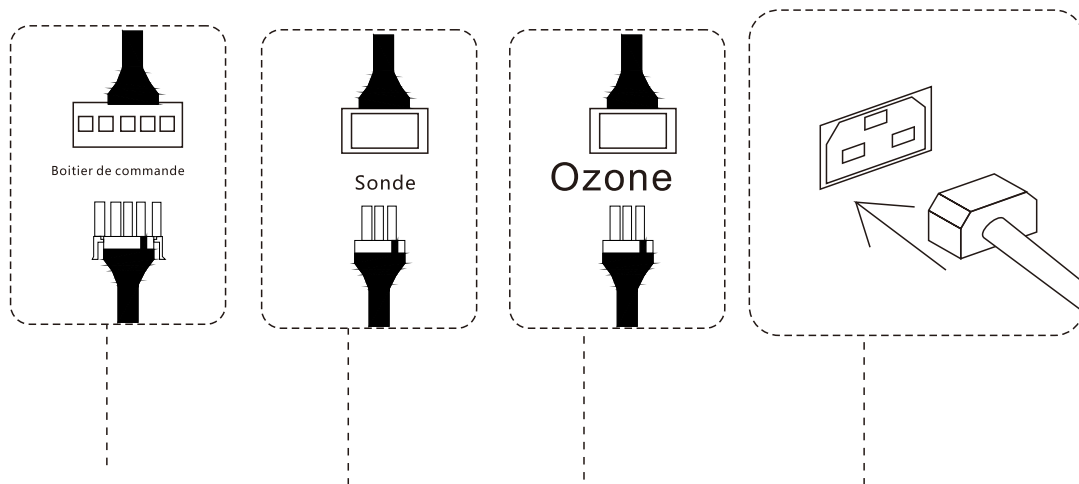

Etape 14

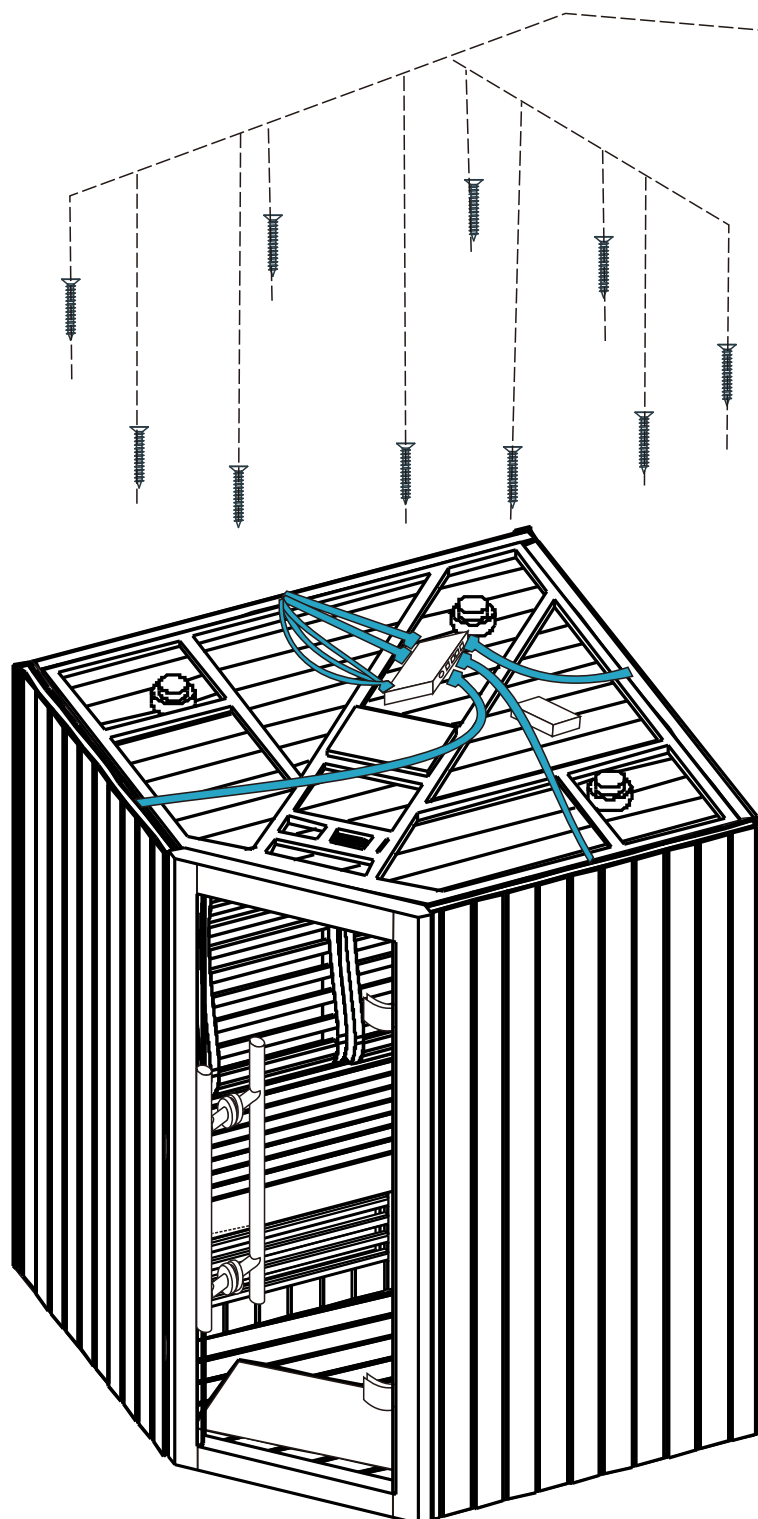
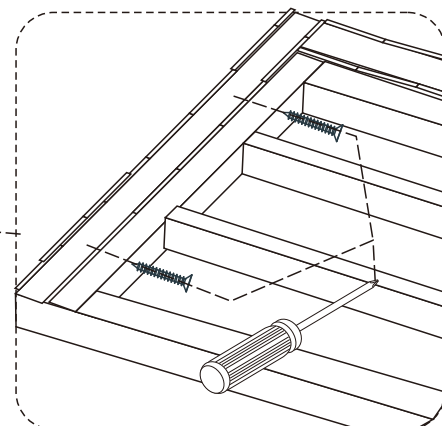
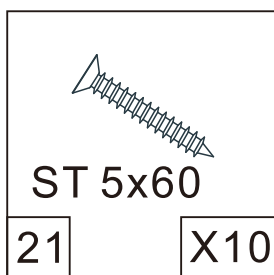

Etape 15

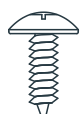

Etape 16

 ø8	 ø10	 ST 4x12			
19	X5	20	X5	24	X10

