

Boreal DIFFUSION 120

Notice d'installation



Modèle Boreal DIFFUSION 120

1200x1000x2000 mm

Tension: AC220-240V







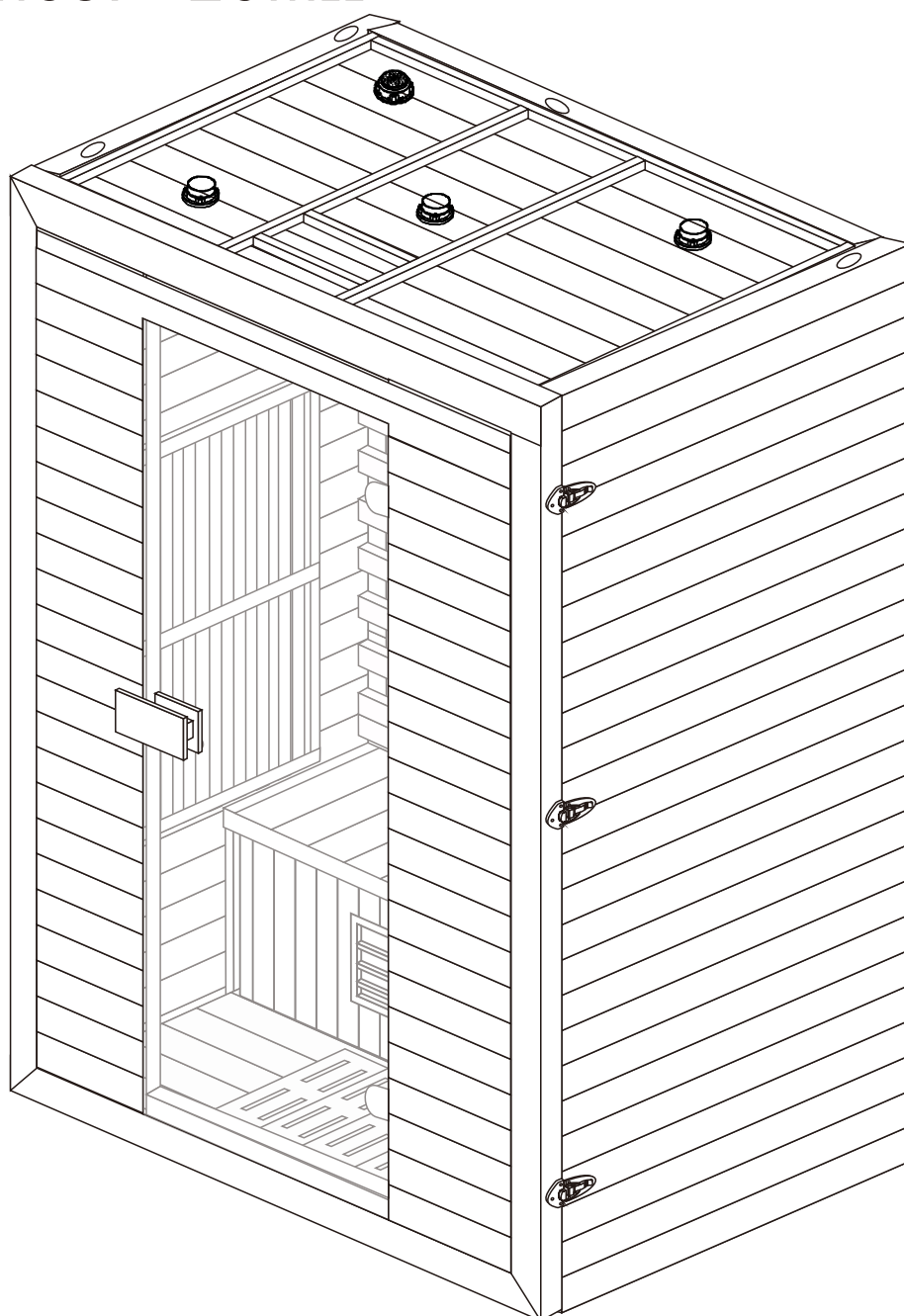

Puissance: 1950W

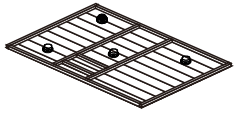
Courant: 8.8A

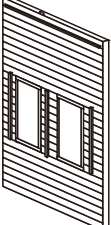
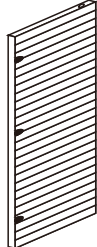
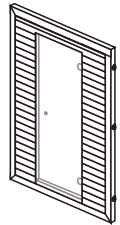
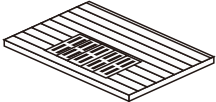
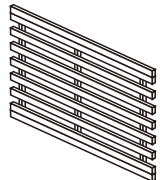
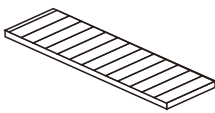
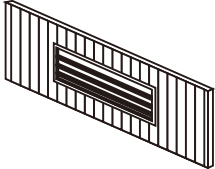
Fréquence nominale: 50/60HZ Insulated

Résistance: $>20M\Omega$

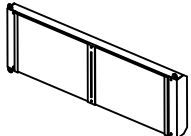

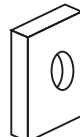
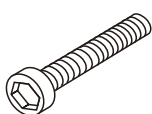
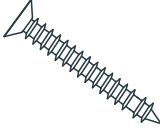
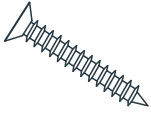
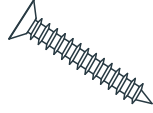
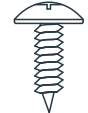
| | | | | | | | | | |
|--|--|--|--|--|---|----|----|----|-----|
|  |  |  |  |  | | | | | |
| 01 | X102 | X103 | X104 | X105 | X1 | | | | |
|  |  |  |  |  | | | | | |
| 06 | X107 | X108 | X109 | X110 | X1 | | | | |
|  |  |  |  |  |  | | | | |
| ø8 | ø10 | | | | | | | | |
| 11 | X10 | 12 | X5 | 13 | X1 | 14 | X2 | 15 | X4 |
|  |  |  |  |  | | | | | |
| | ST 3x18 | ST 5x60 | ST 4x35 | ST 4x12 | | | | | |
| 16 | X2 | 17 | X4 | 18 | X14 | 19 | X2 | 20 | X15 |

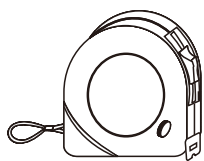
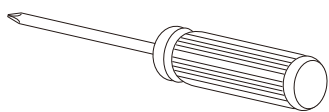

4mm
2.5mm

Etape 1

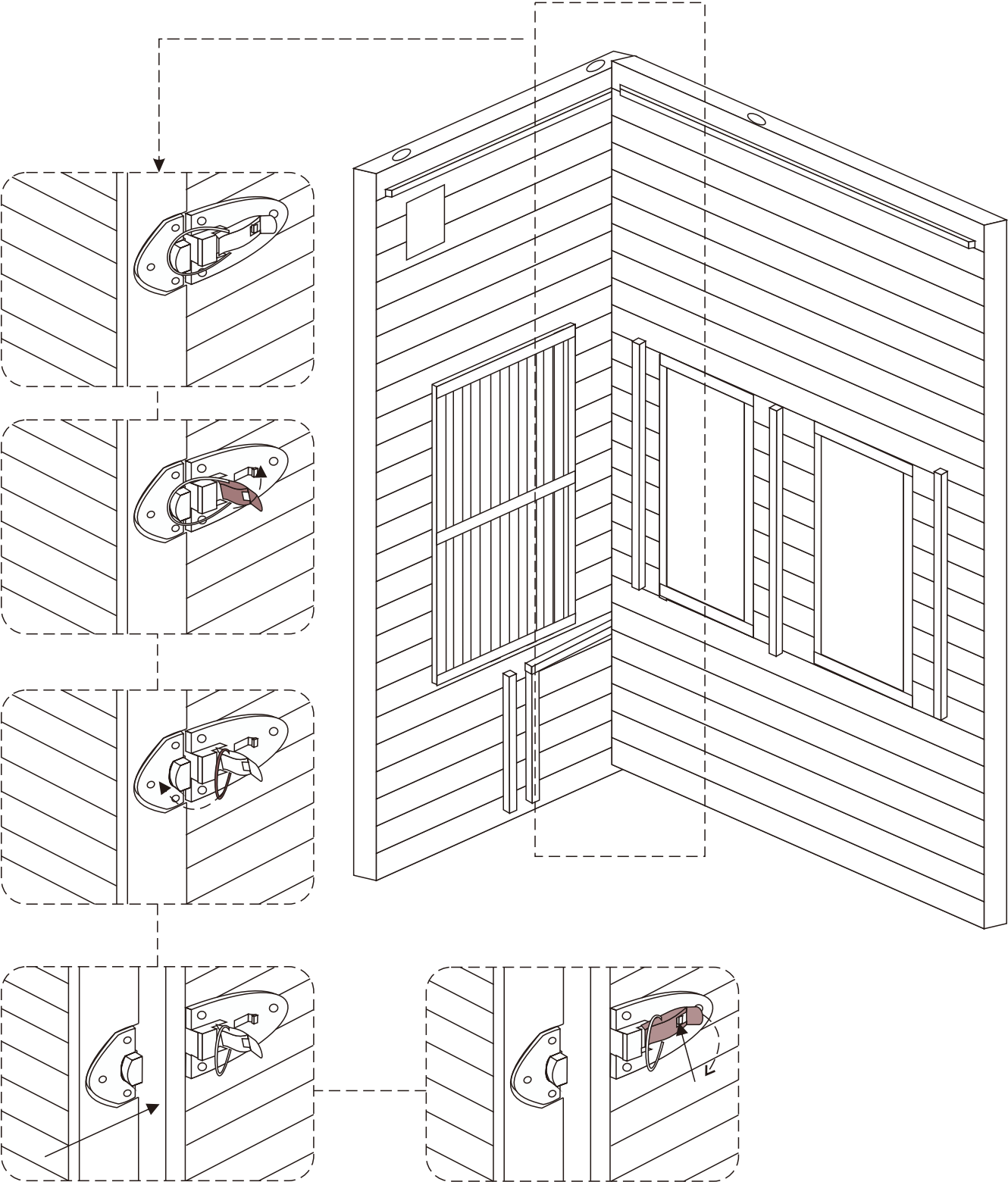
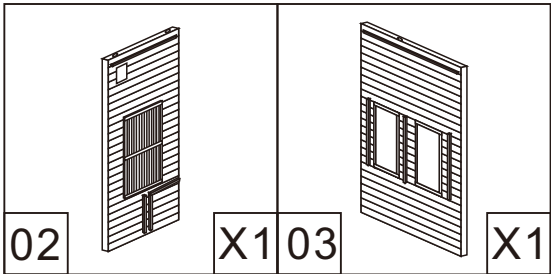

Etape 2

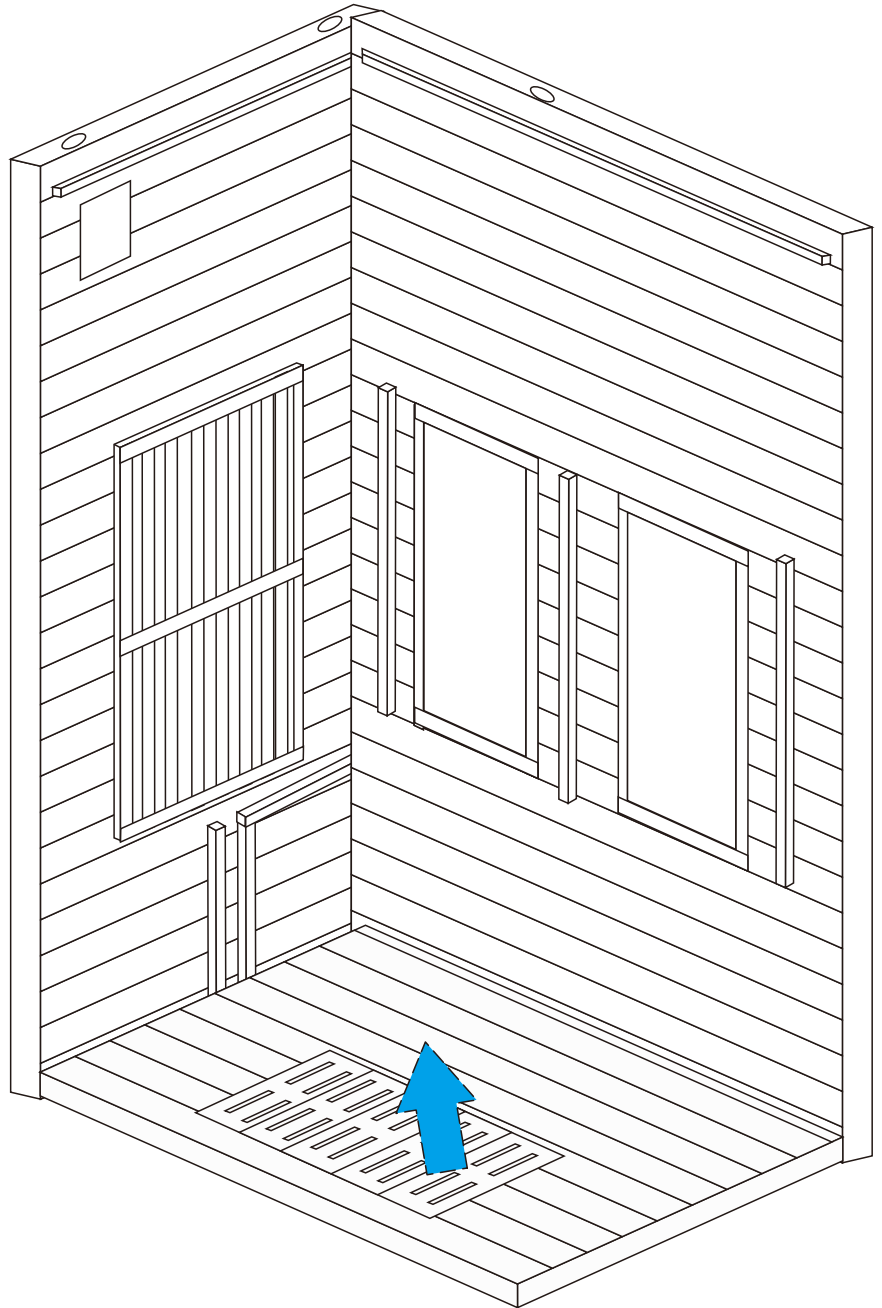
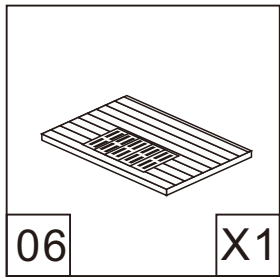

Etape 3

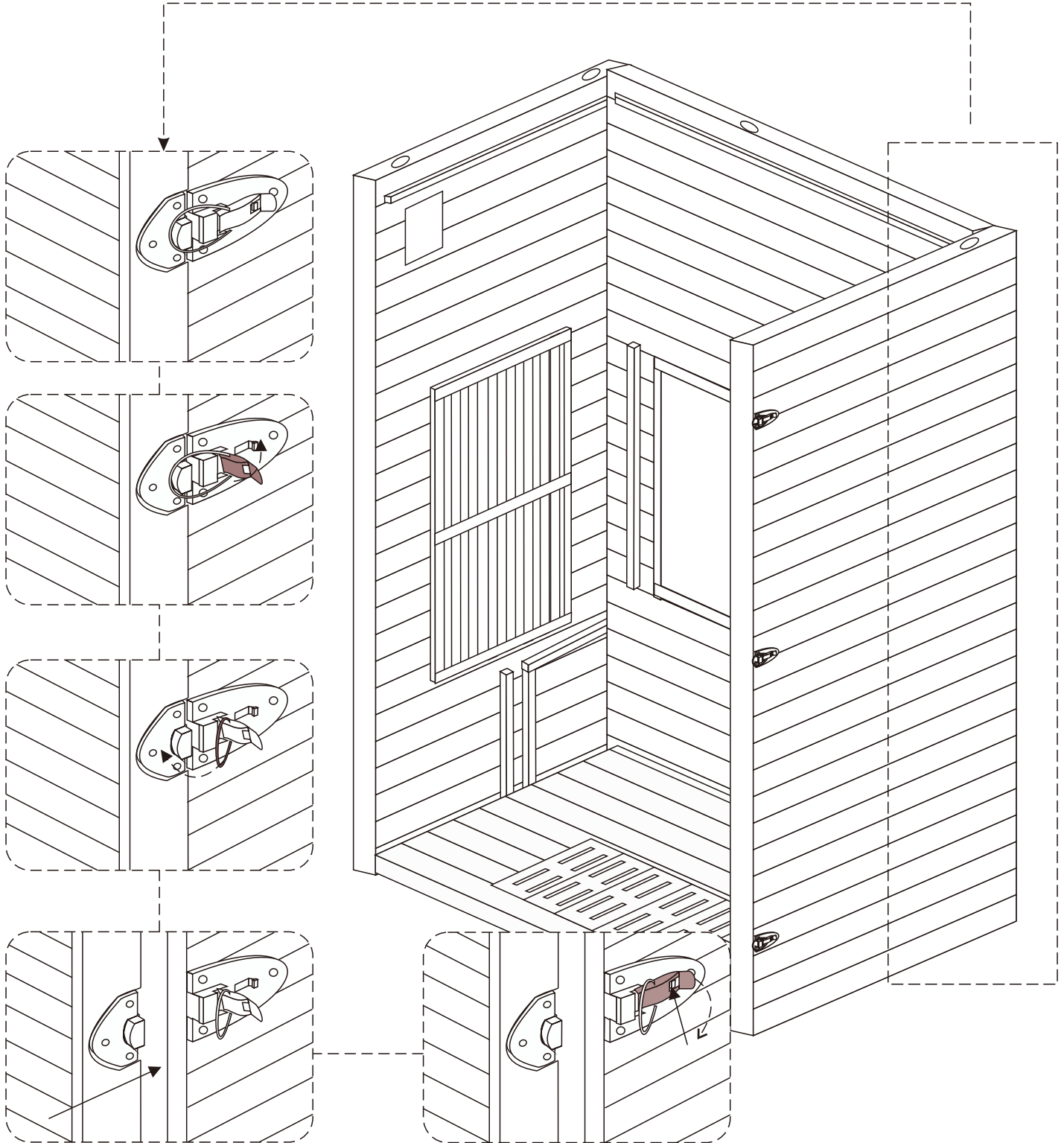
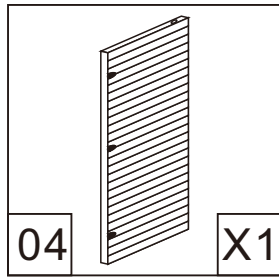

Etape 4

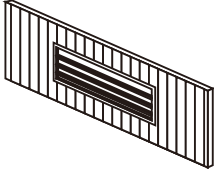
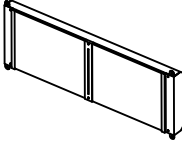
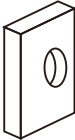
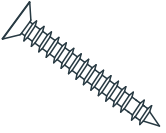
| | | | | |
|---|---|---|--|----|
|  |  |  |  ST 3x18 | |
| 09 | X1 13 | X1 15 | X4 17 | X4 |

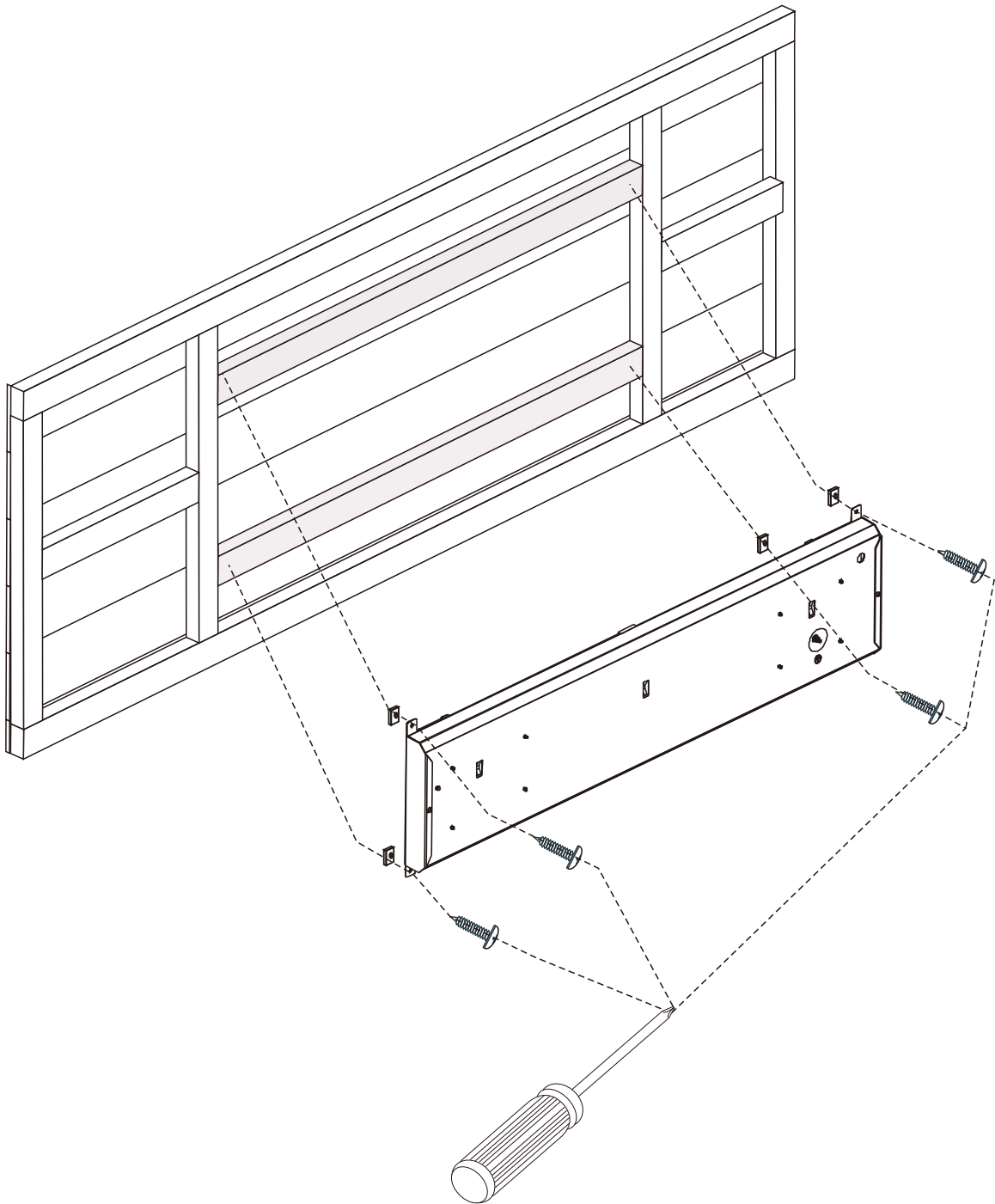

P5

Etape 5

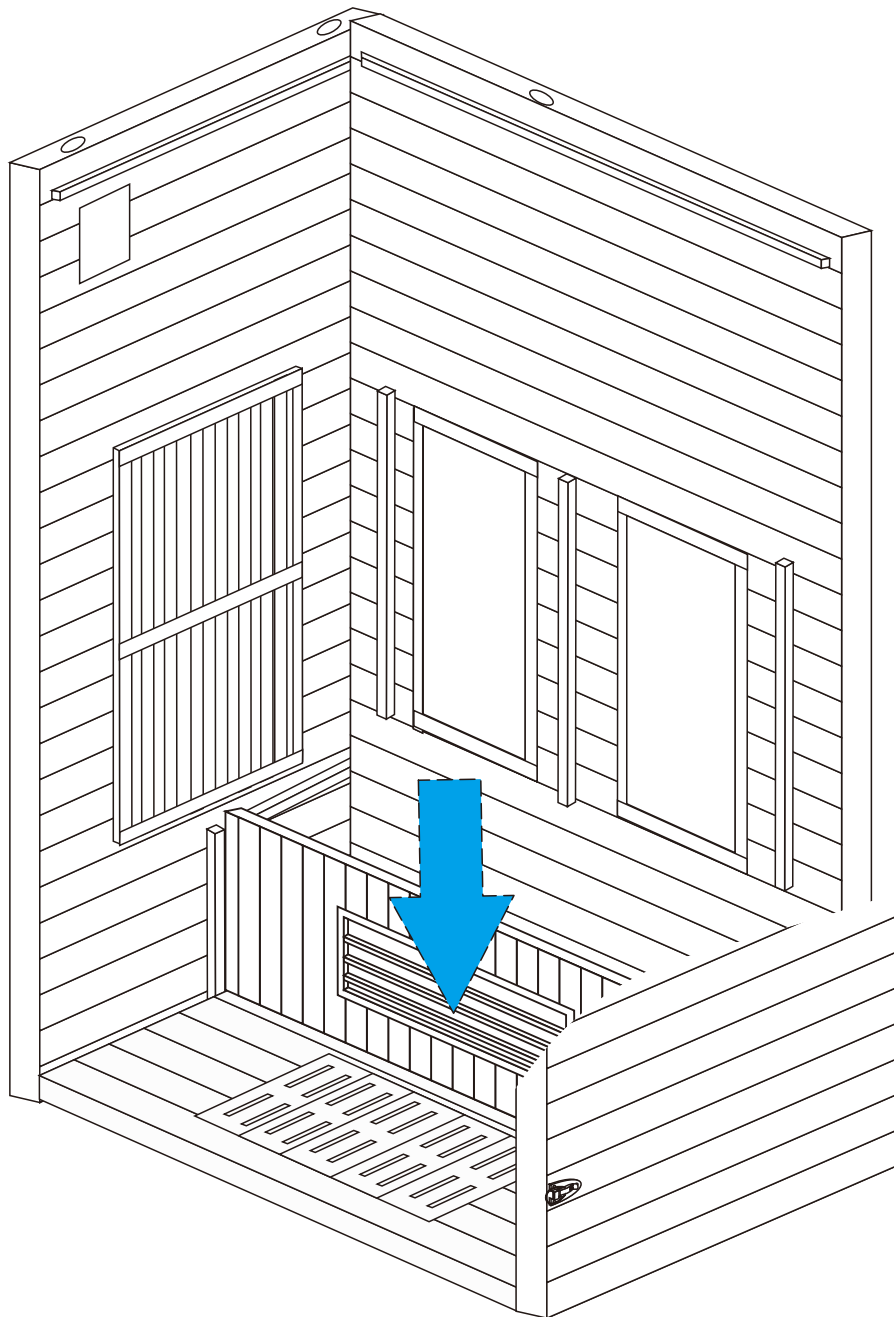
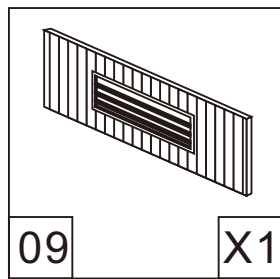

Etape 6

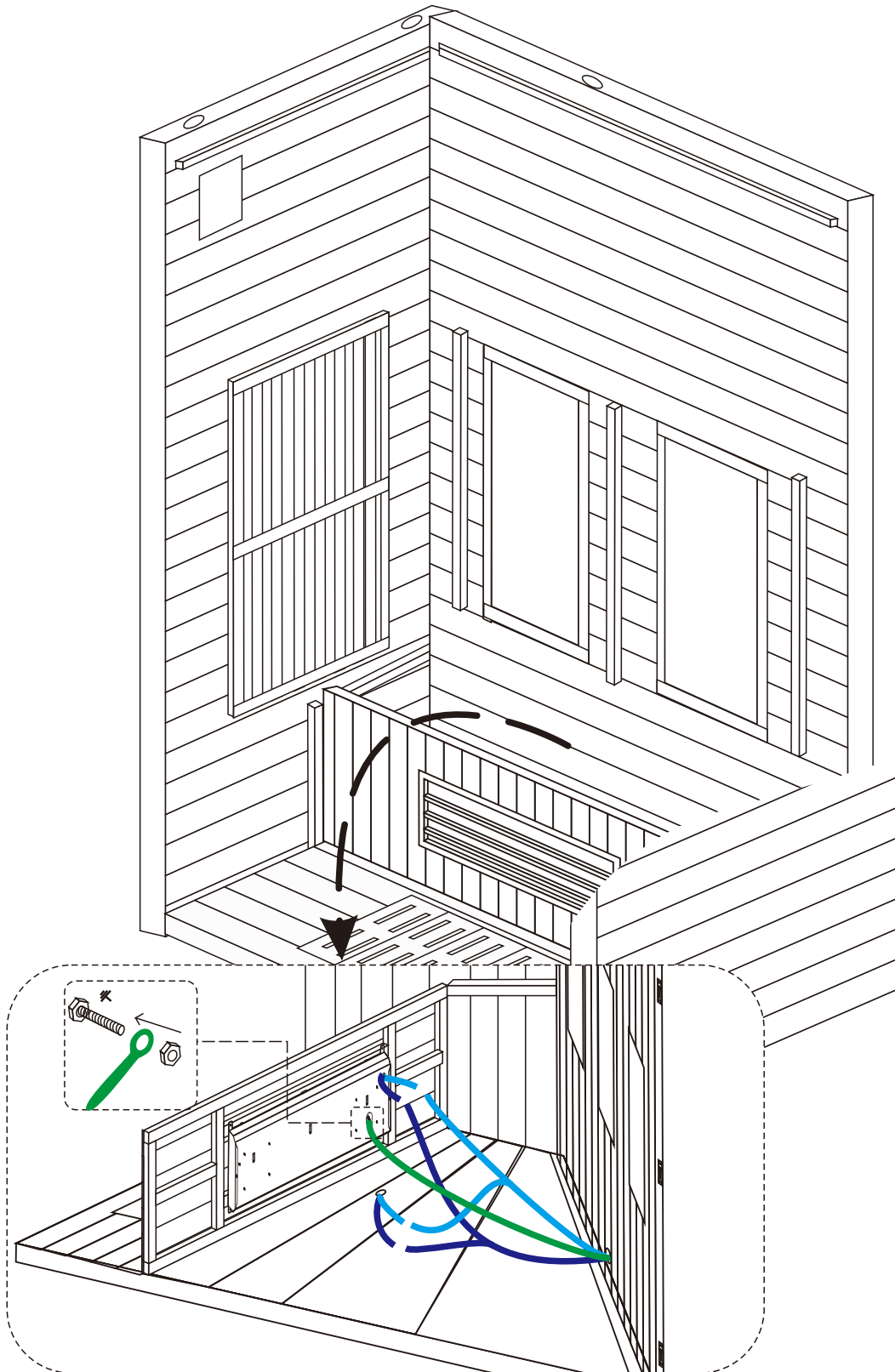
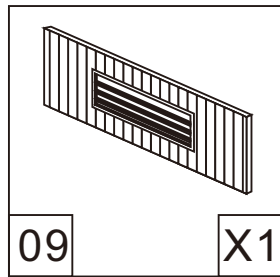

Etape 7

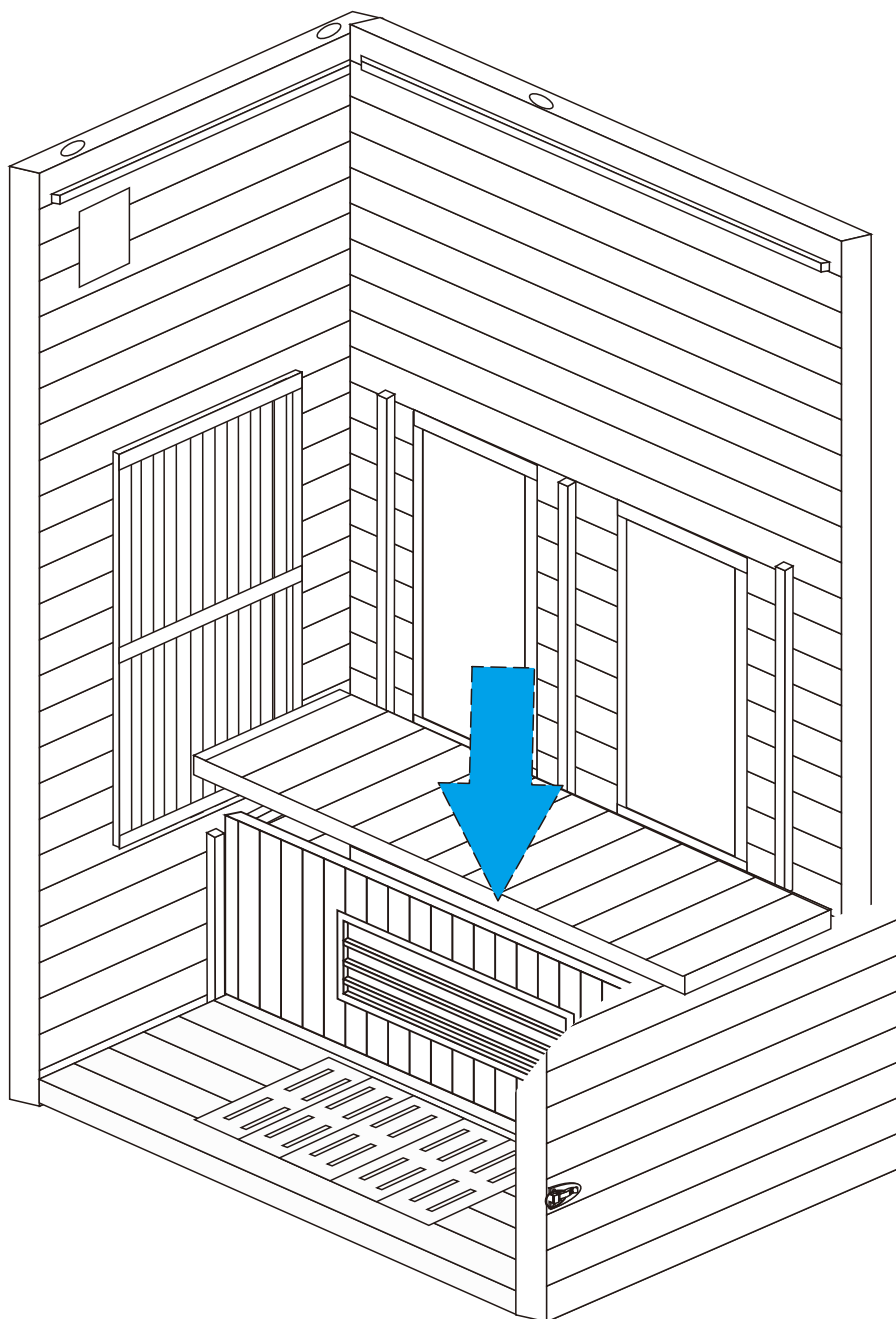
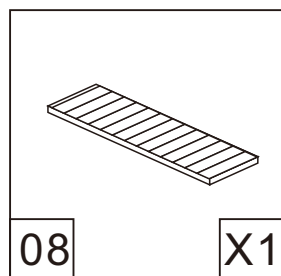

Etape 8

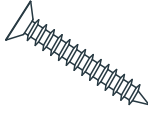
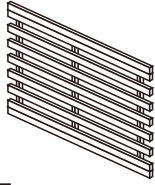
| | | | |
|--|-------|---|----|
|  ST 5x50 | |  | |
| 18 | X6 07 | | X1 |

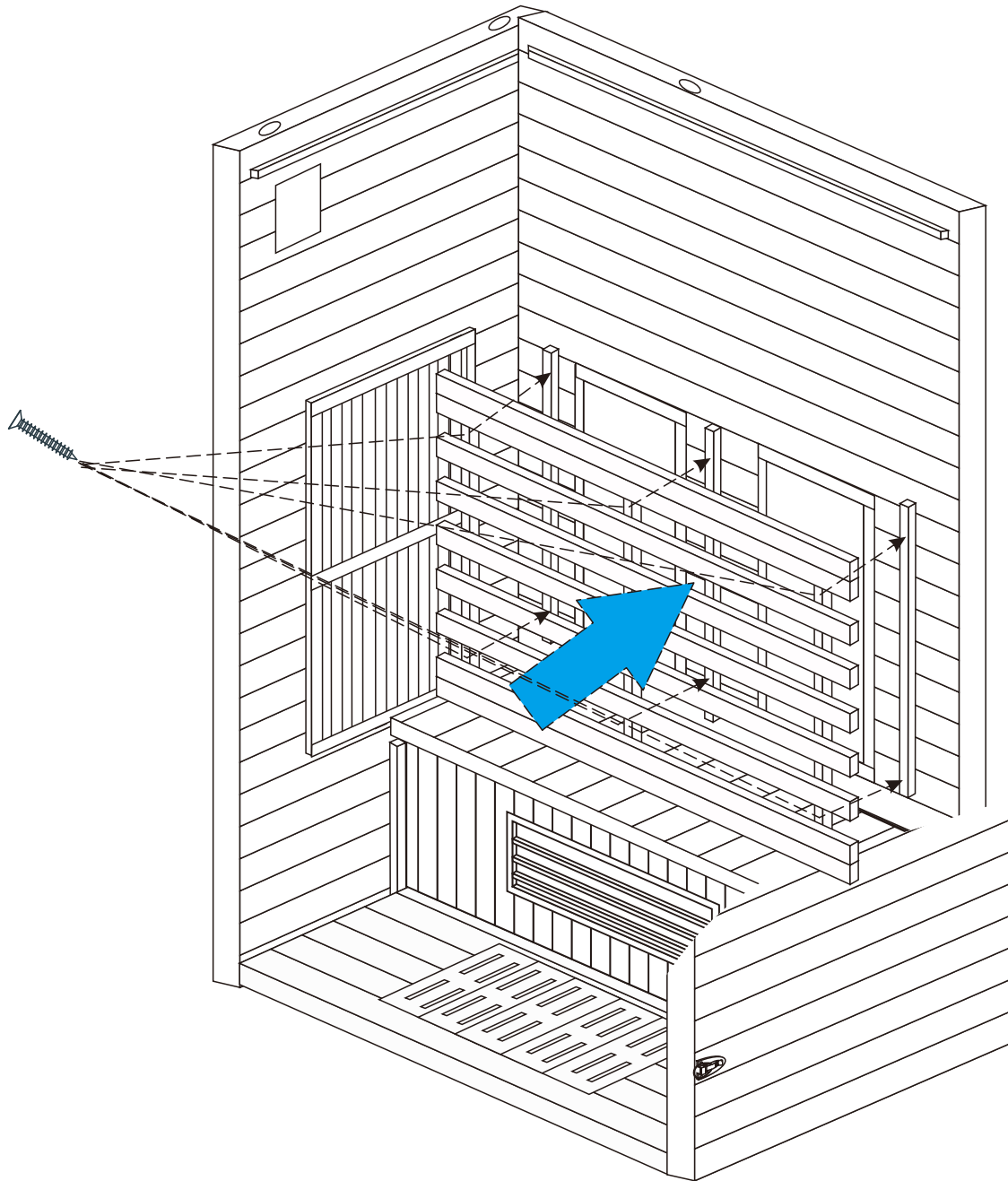

Etape 9

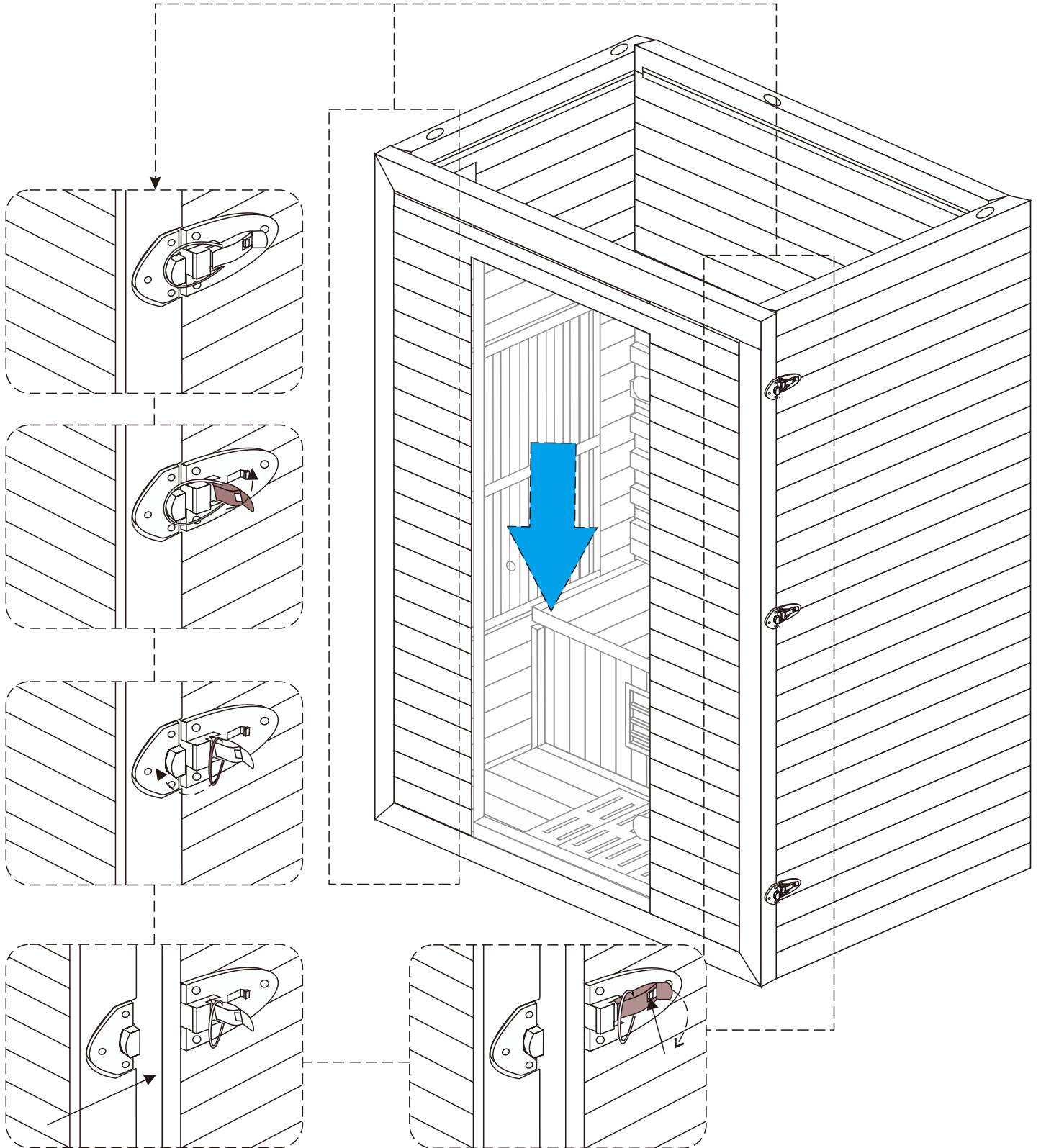
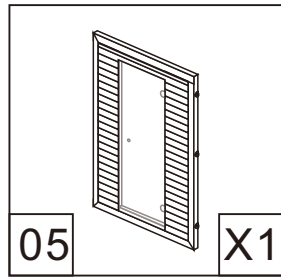

Etape 10

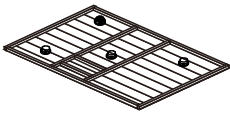
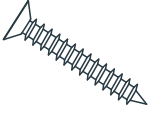
| | | |
|---|--|----|
|  |  ST 5x60 | |
| 01 | X1 18 | X8 |

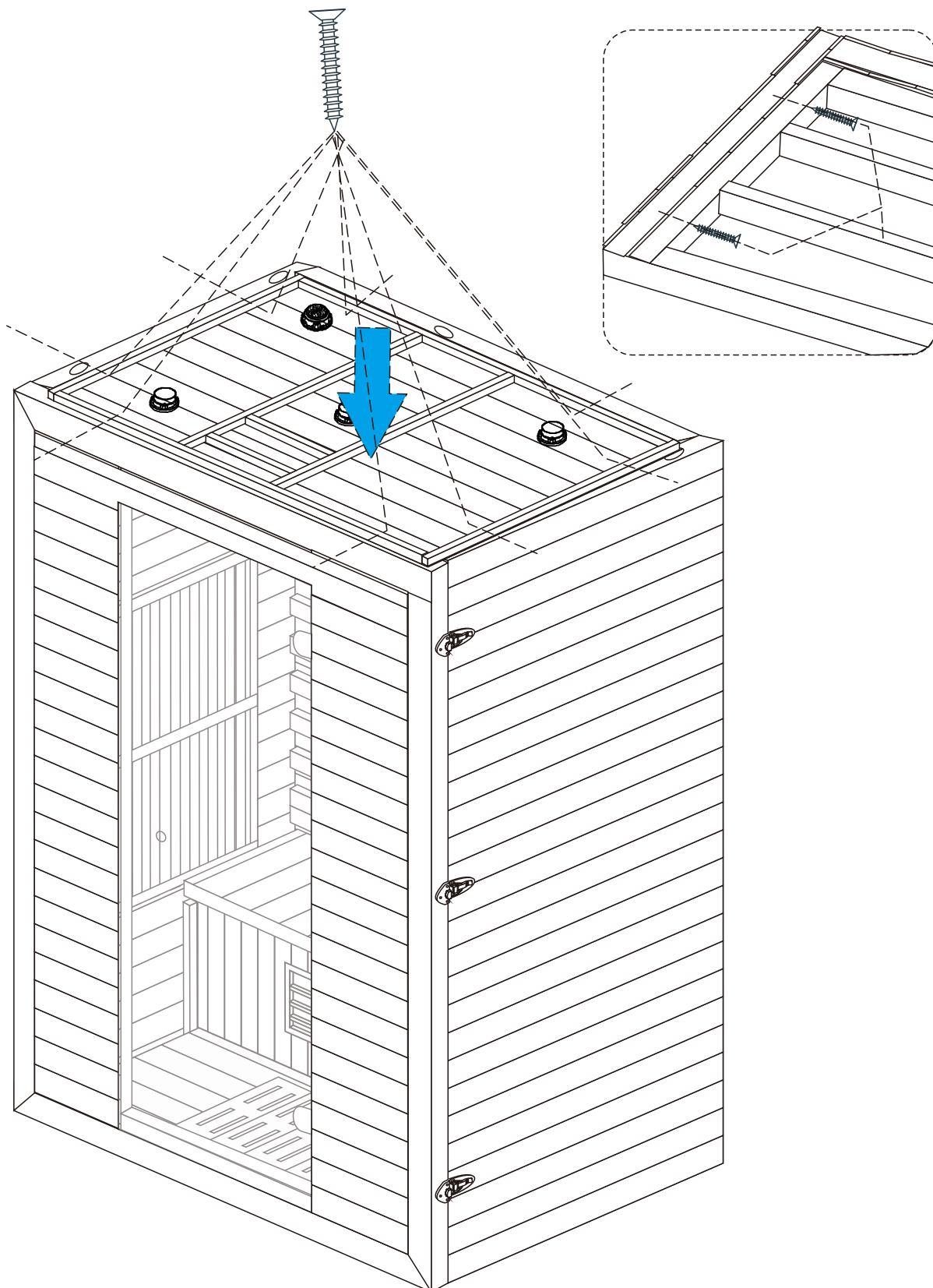

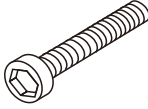
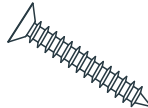

Etape 11

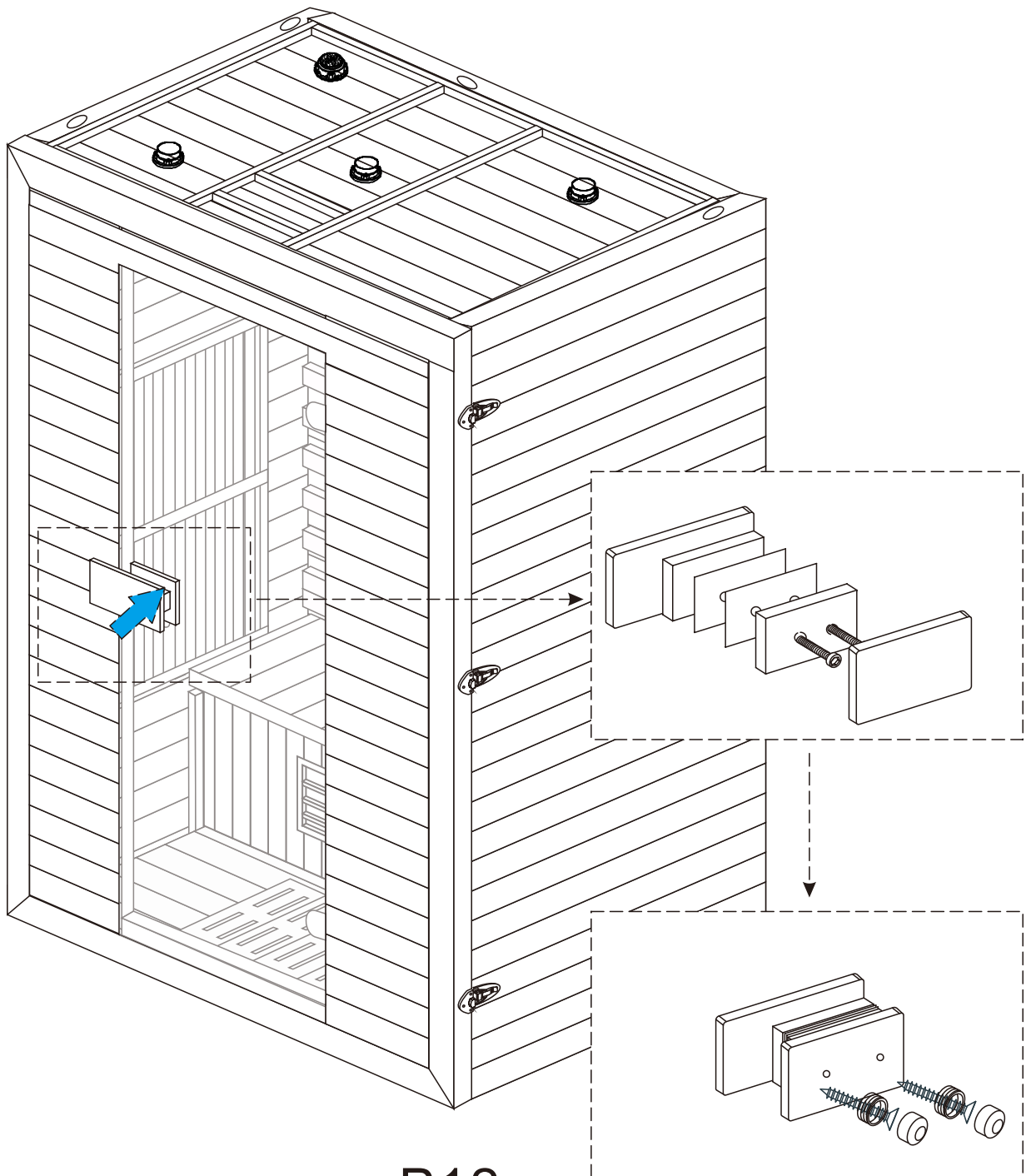
| | | | |
|---|---|--|----|
|  |  |  ST 4X35 | |
| 10 | X1 16 | X2 19 | X2 |

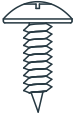

P12

Etape 12

| | | | |
|--|---|--|----|
|  ST 4x12 |  ø8 |  ø10 | |
| 20 | X15 11 | X10 12 | X5 |

