

Boreal DIFFUSION 140C

Notice d'installation



Modèle Boreal DIFFUSION 140C

1400x1400x2000mm

Tension: AC220-240V





Puissance: 3050W

Courant: 13.8A

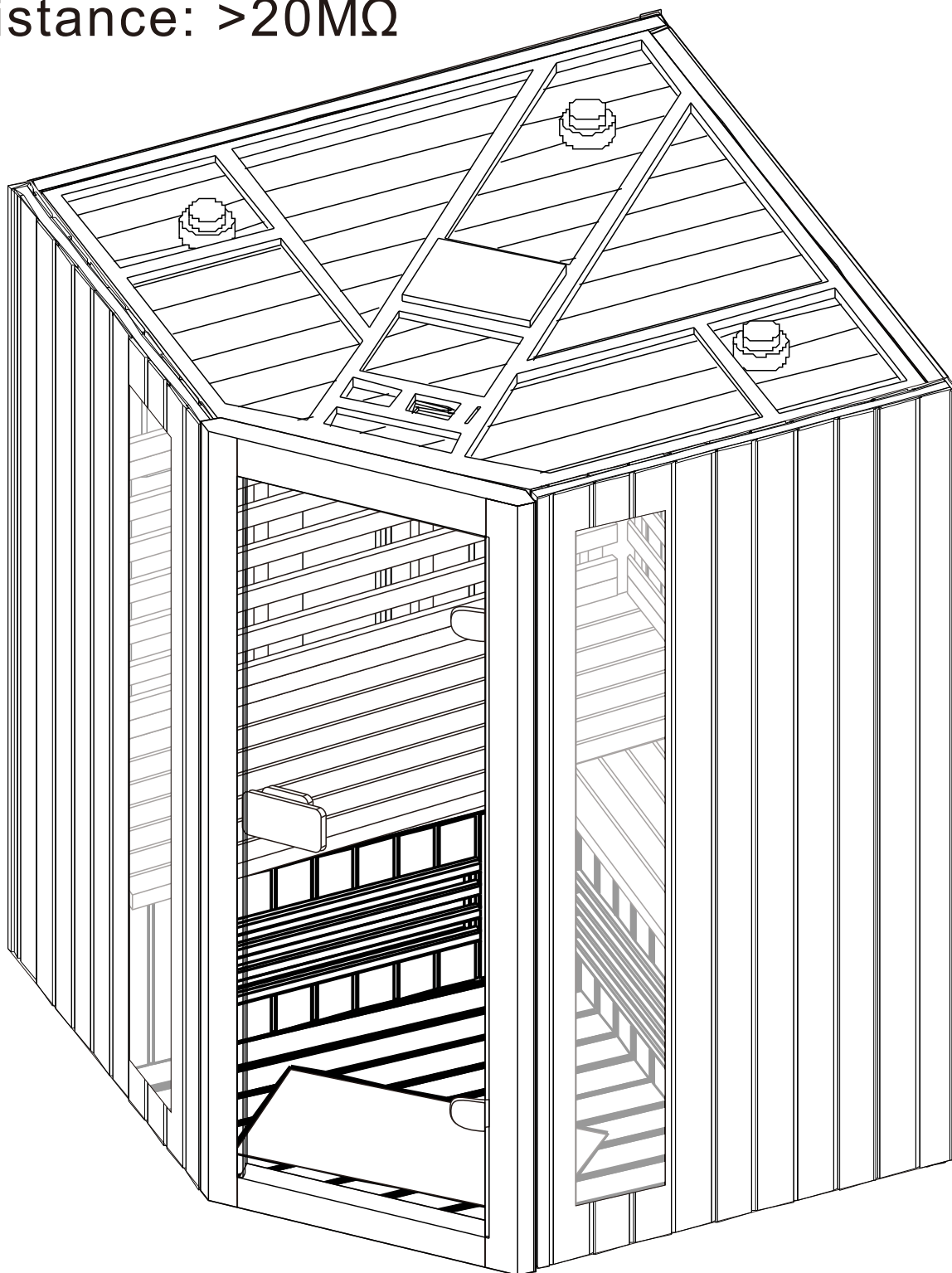
Fréquence nominale: 50/60HZ

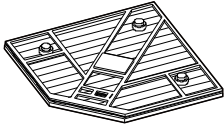
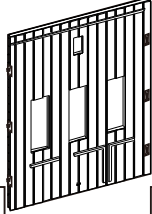
Résistance: >20M Ω

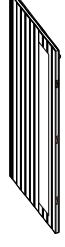
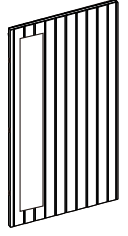
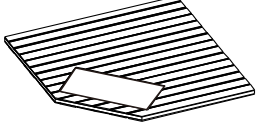
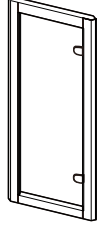
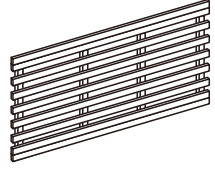
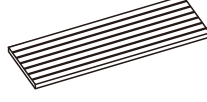
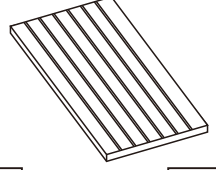
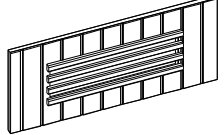
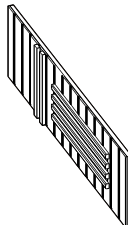
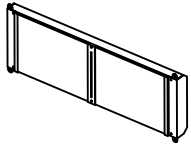
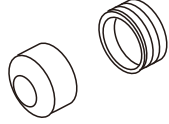
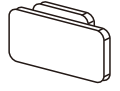
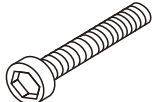
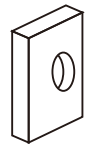
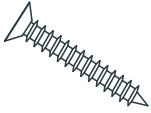

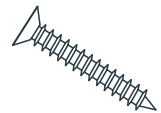
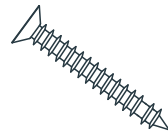
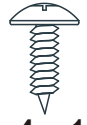
				
01	X102	X103	X104	X105
				
06	X107	X108	X209	X110
				
11	X112	X113	X214	X215
				
16	X217	X818	X219	X1020
			ST 5x60	ø8
				ø10
				X5
				
21	X222	X823	X15	

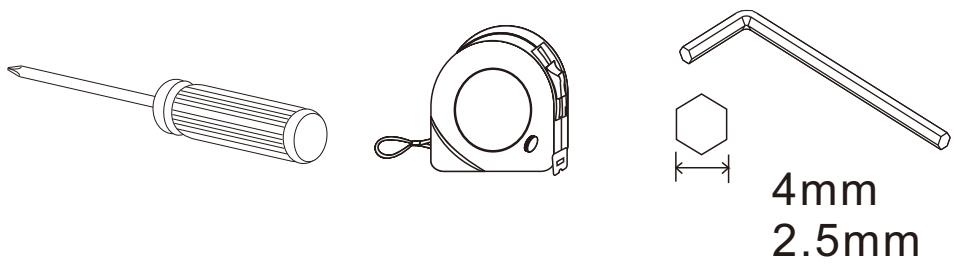

Etape 1

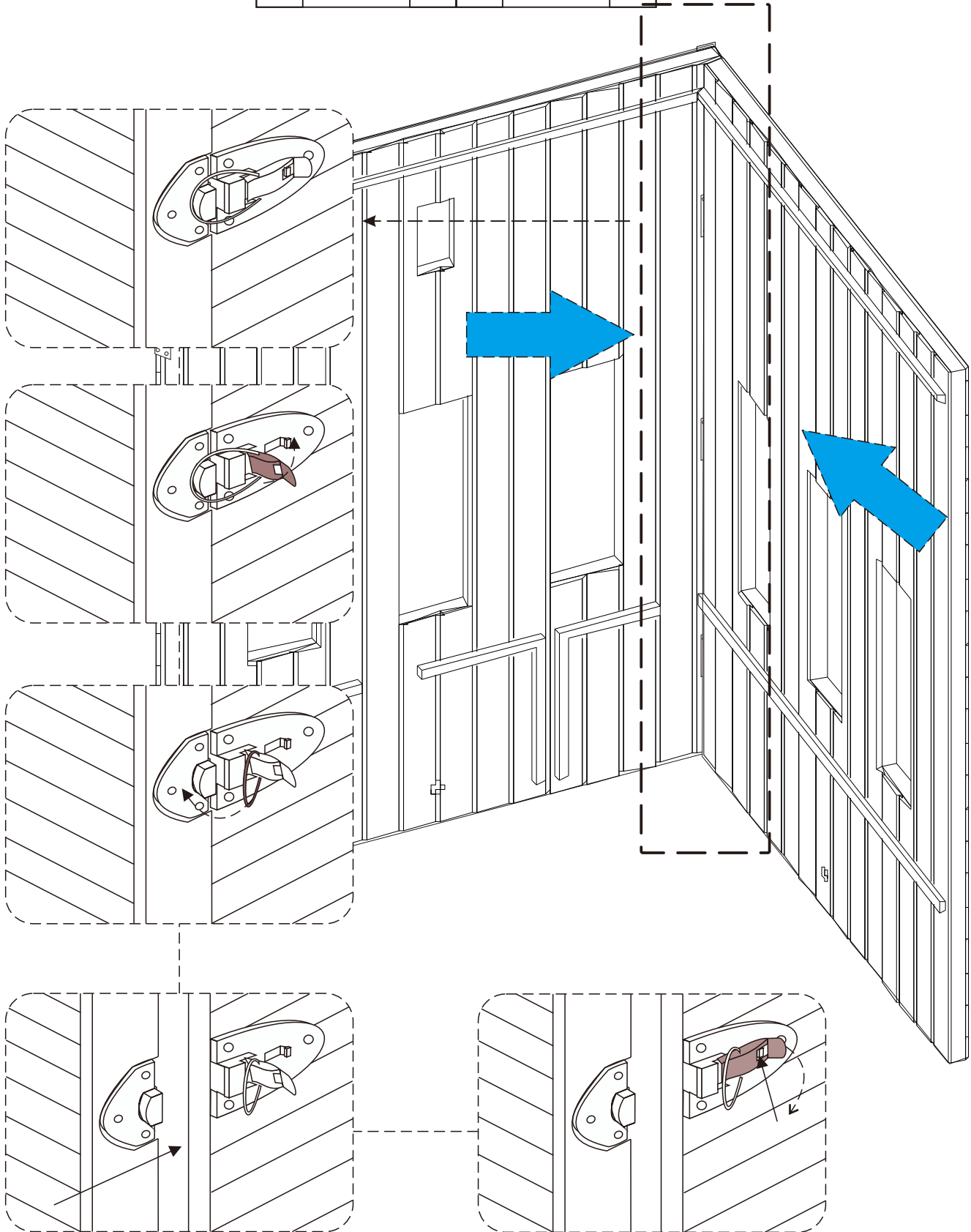
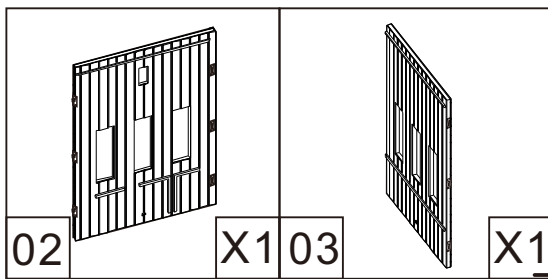

Etape 2

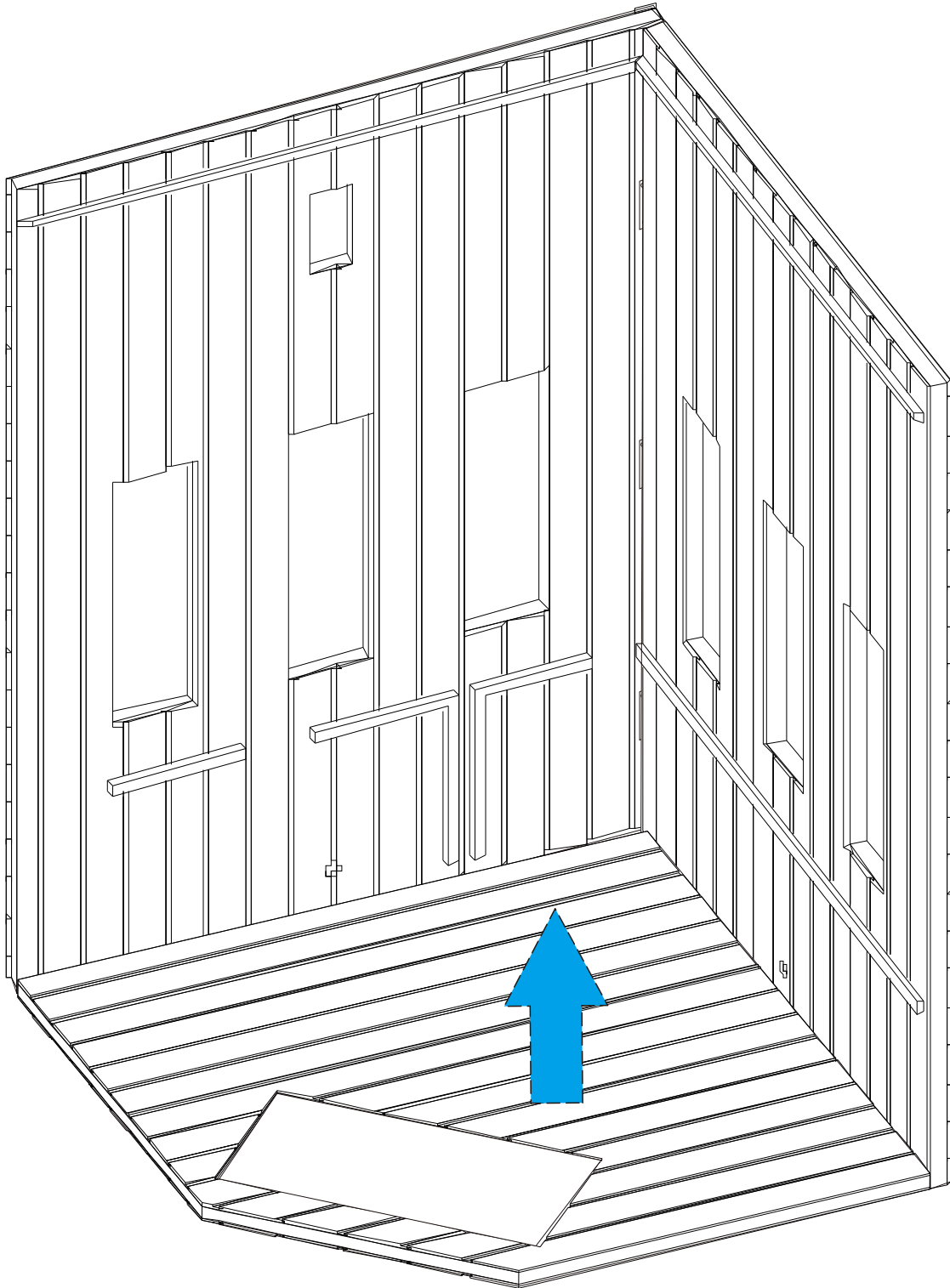
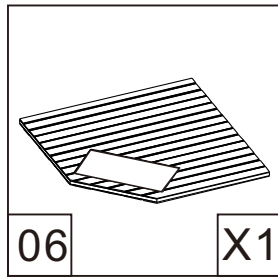

Etape 3

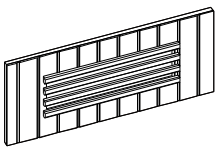
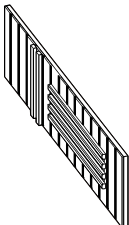
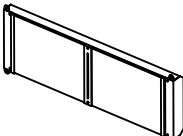
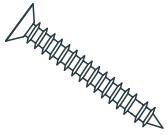
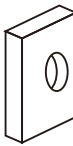
			 ST 3x18	
11	X1 12	X1 13	X2 22	X8
				
17	X8			

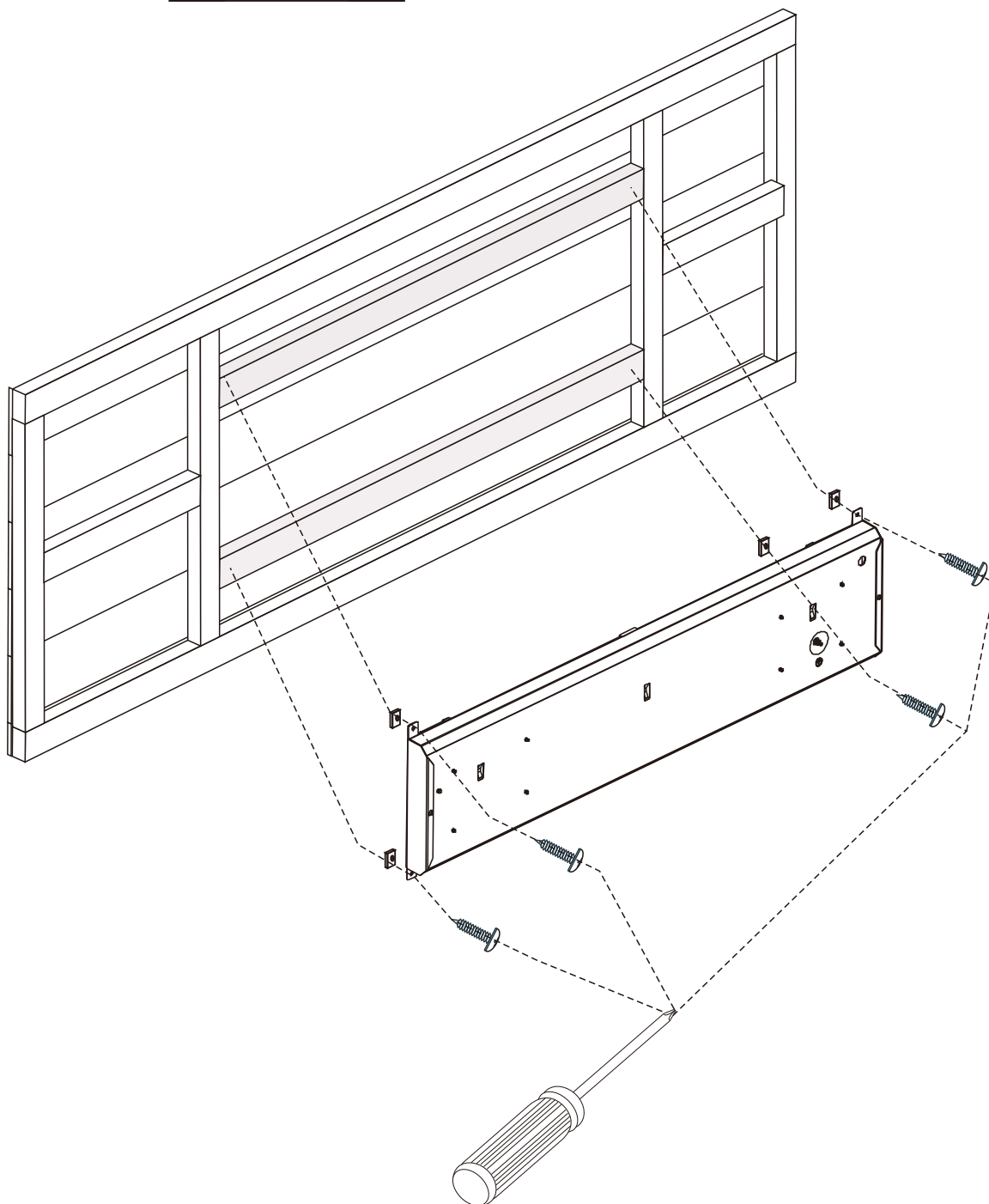

Etape 4

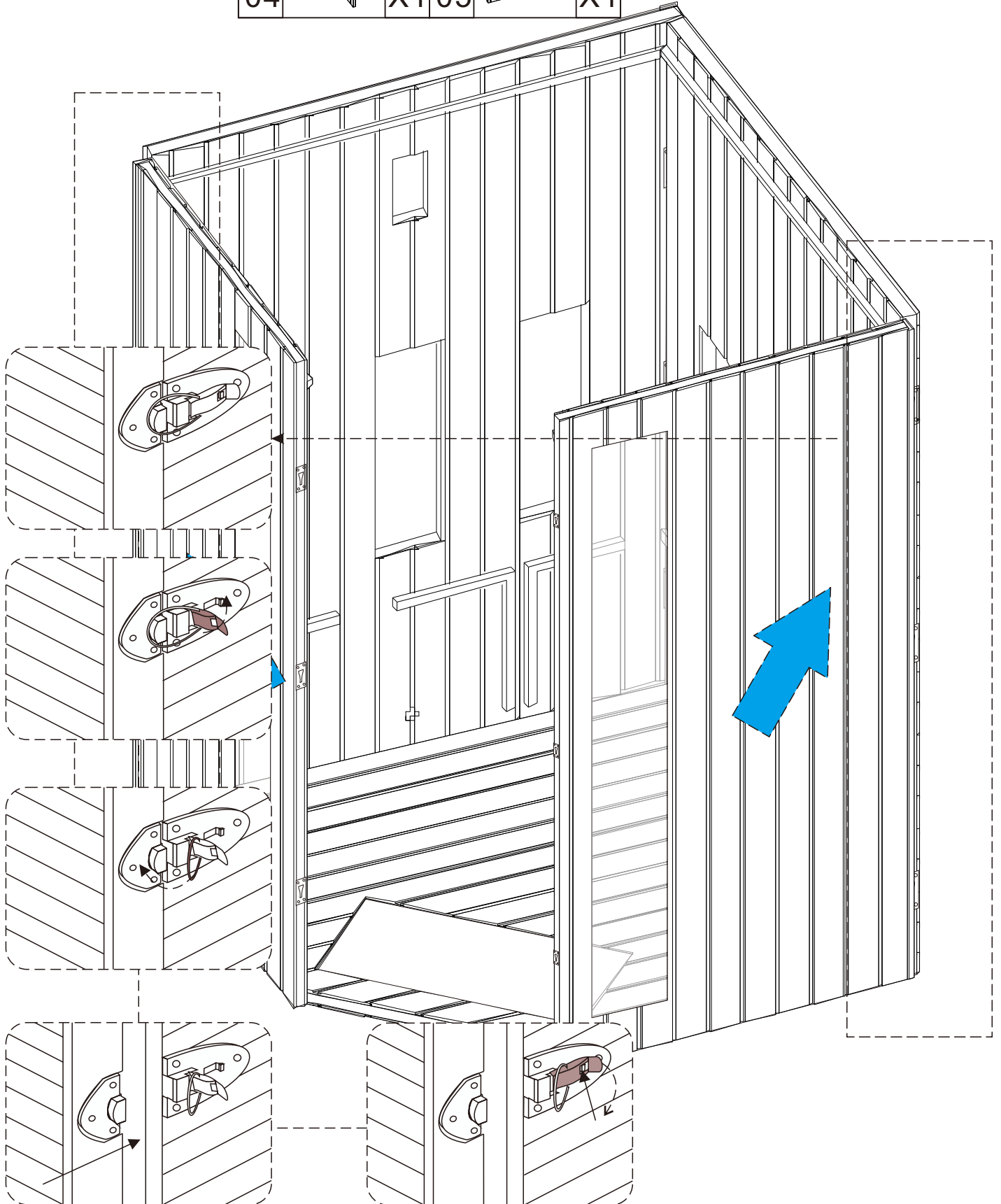
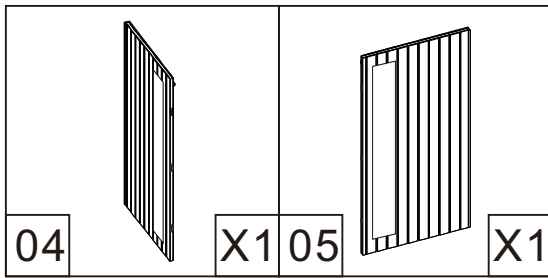

Etape 5

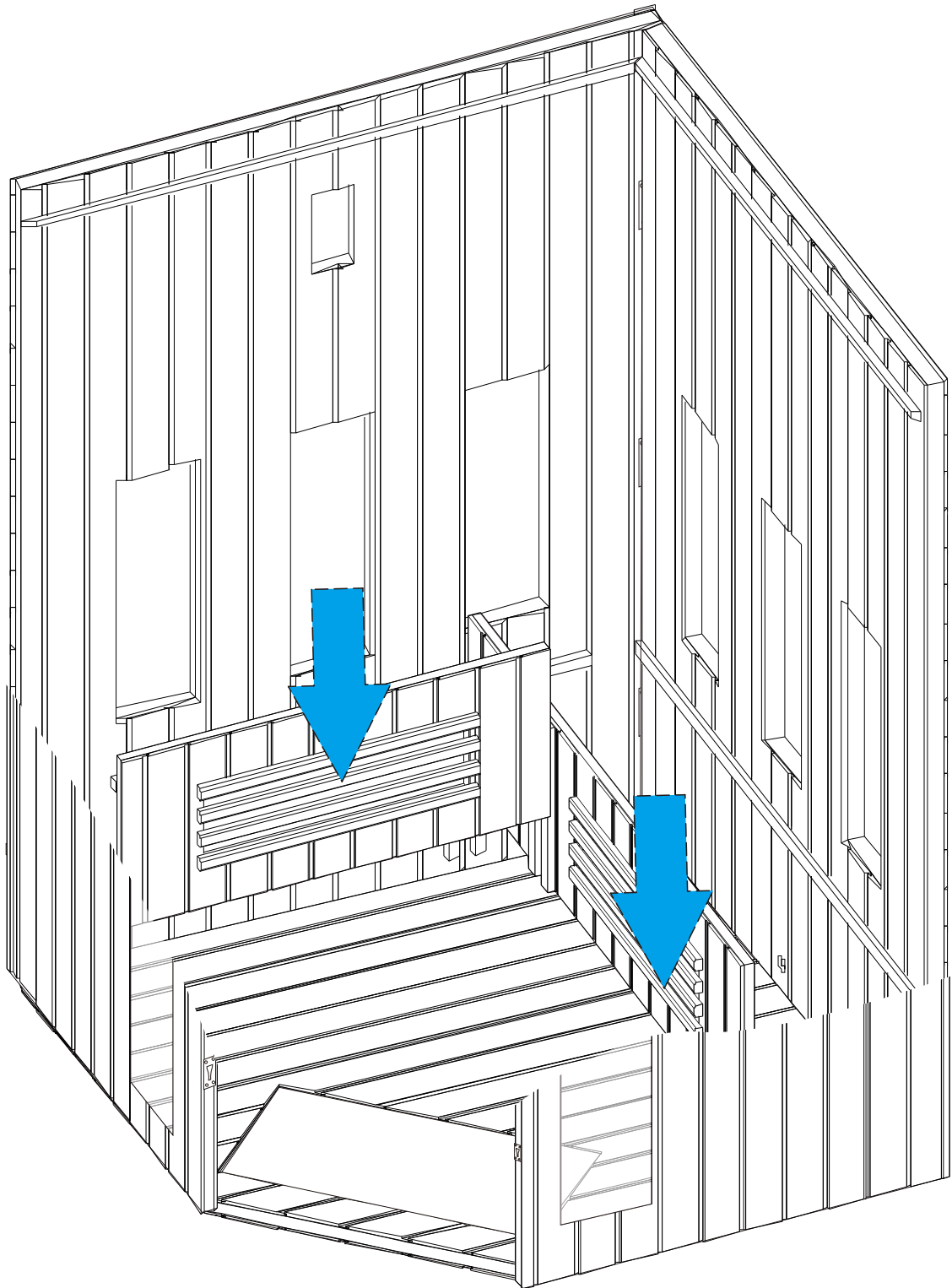
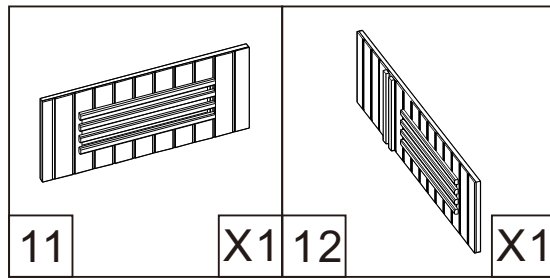

Etape 6

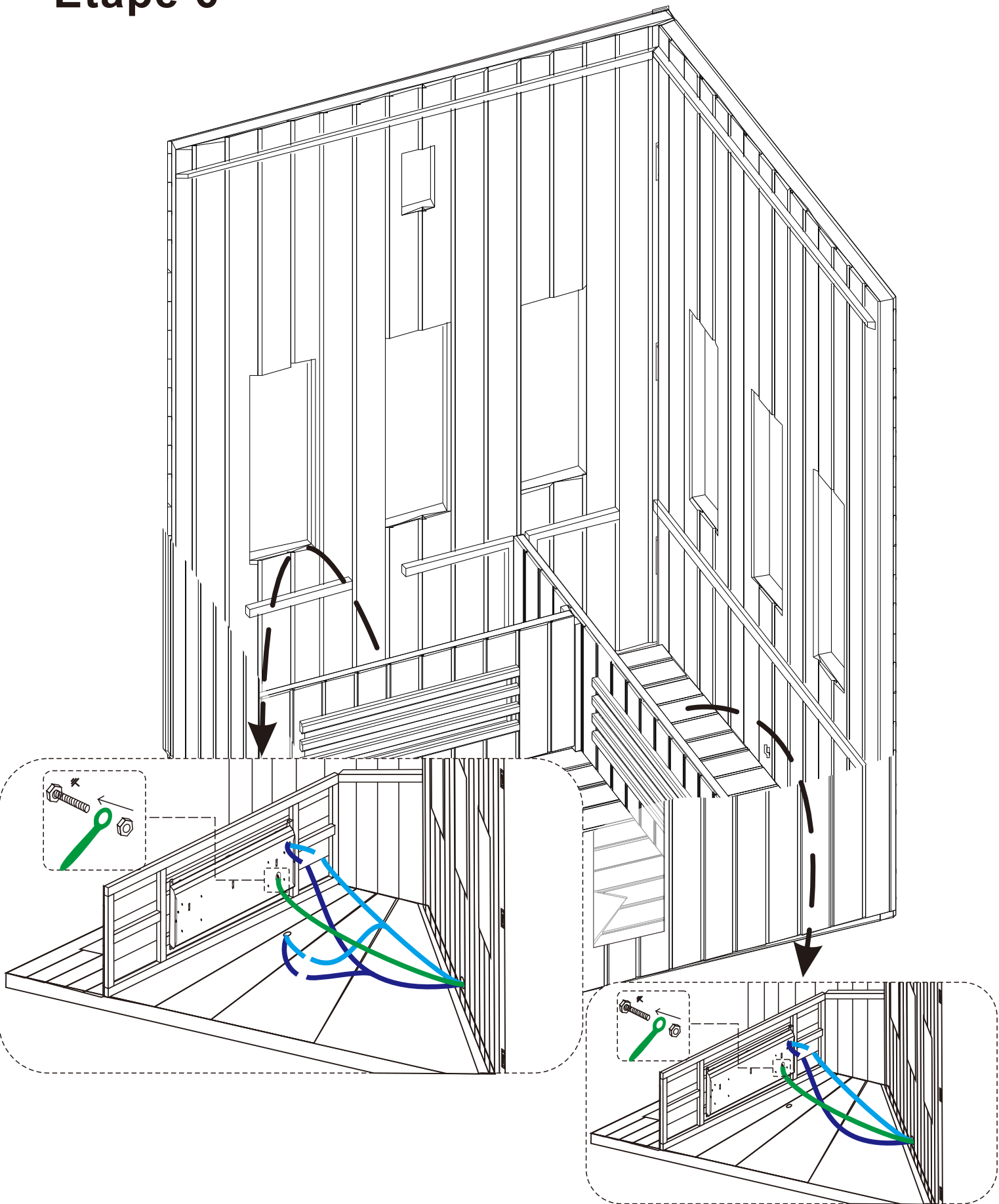

Etape 7

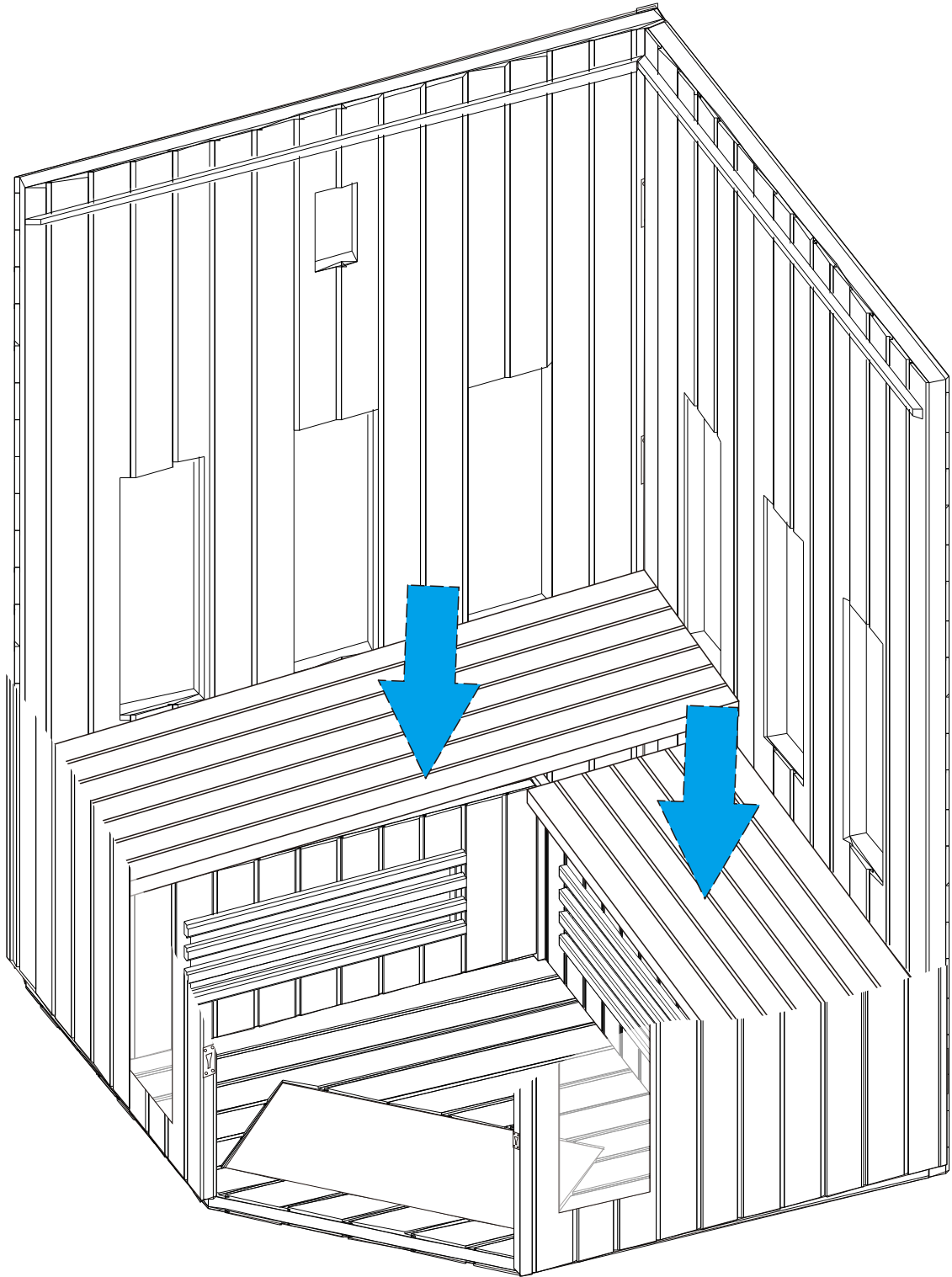
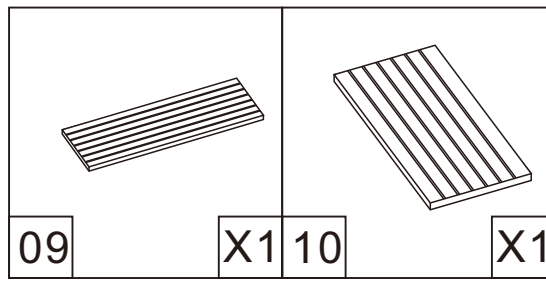

Etape 8

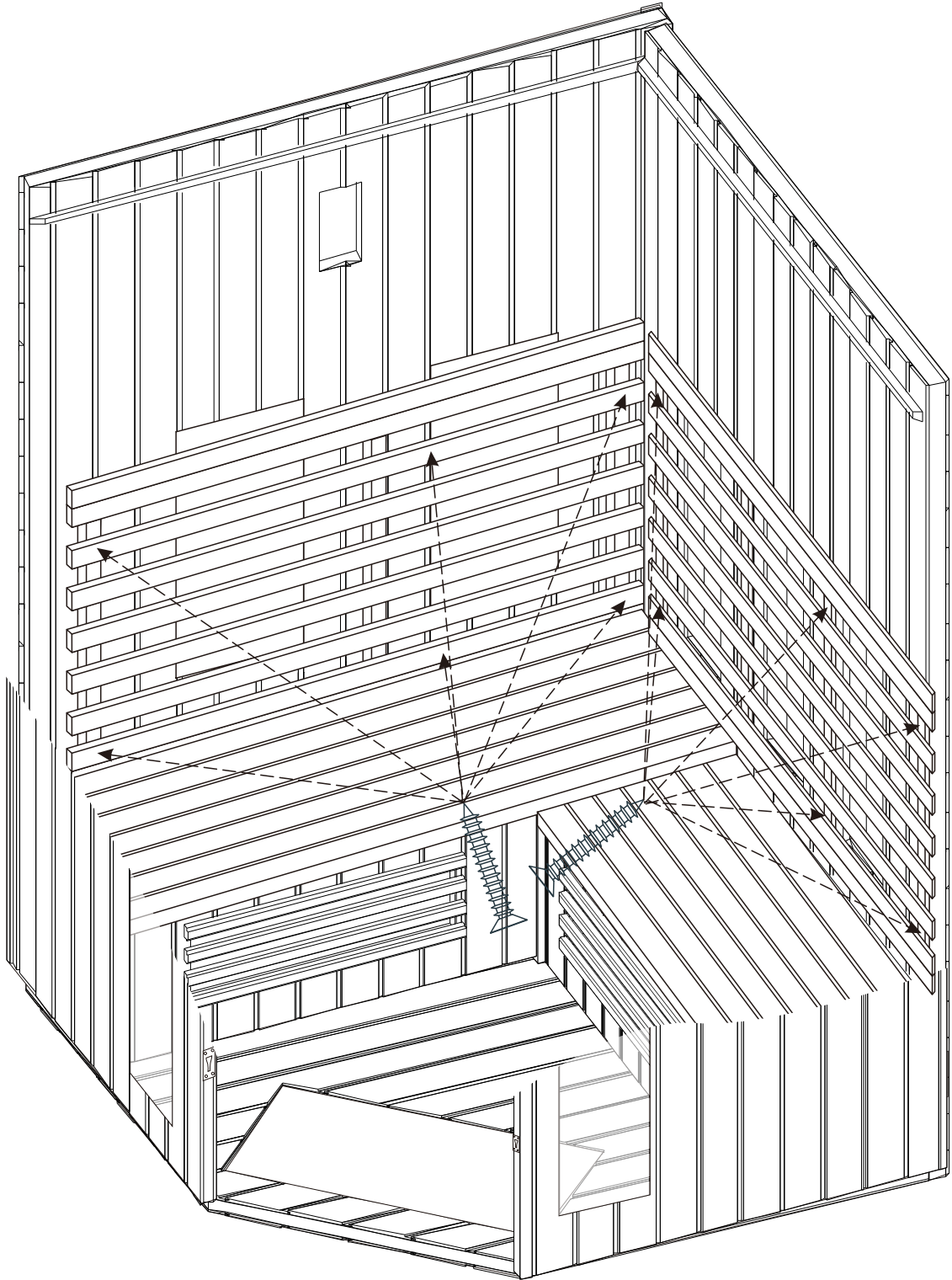
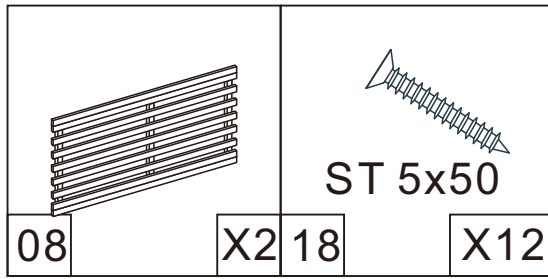

Etape 9

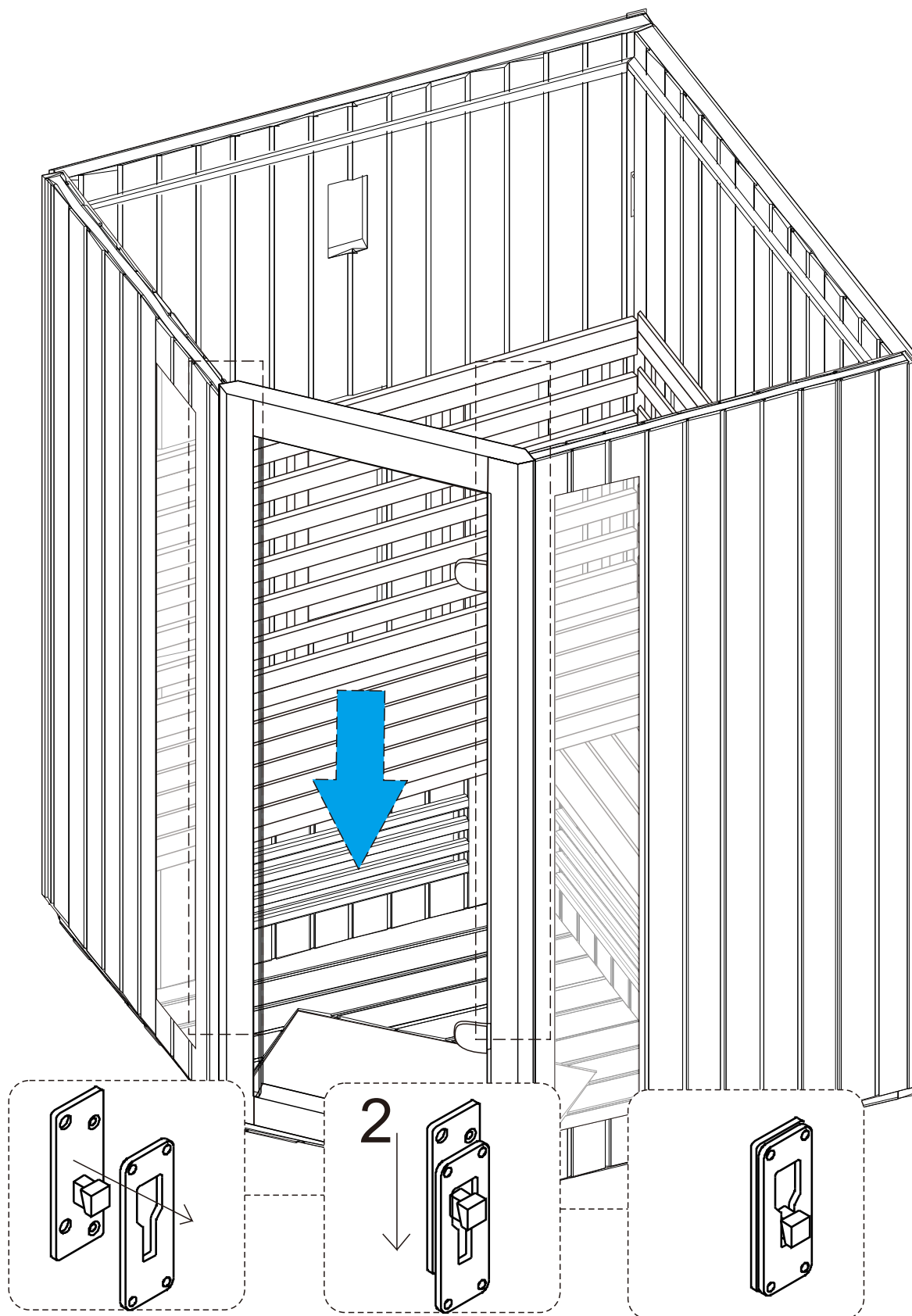
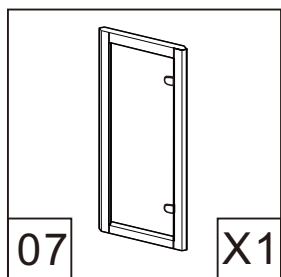

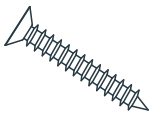

P10

Etape 10

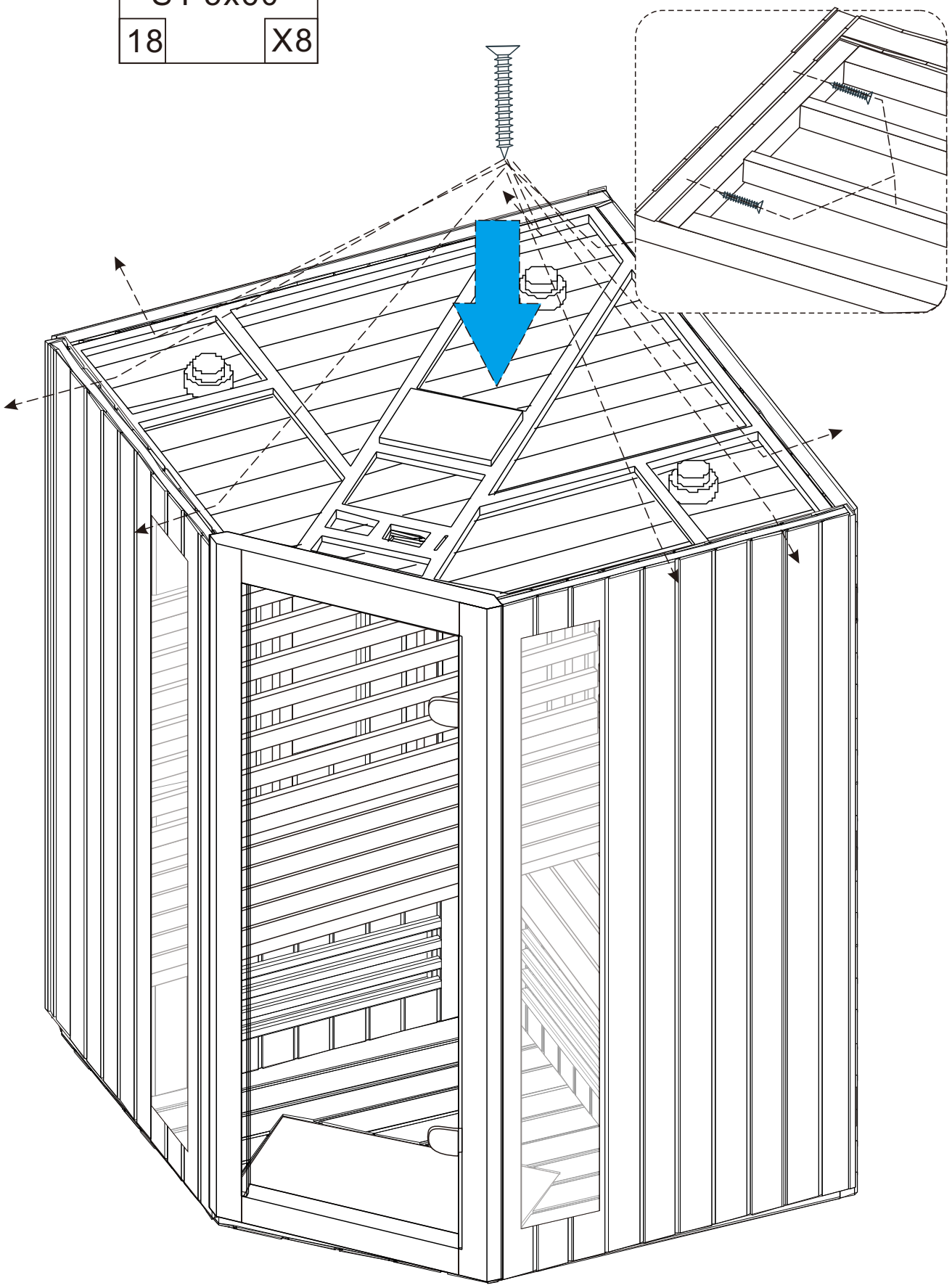
	
ST 5x60	
18	X8

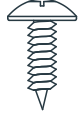

Etape 11

 ø8	 ø10	 ST 4x12	
19	X10 20	X5 23	X15

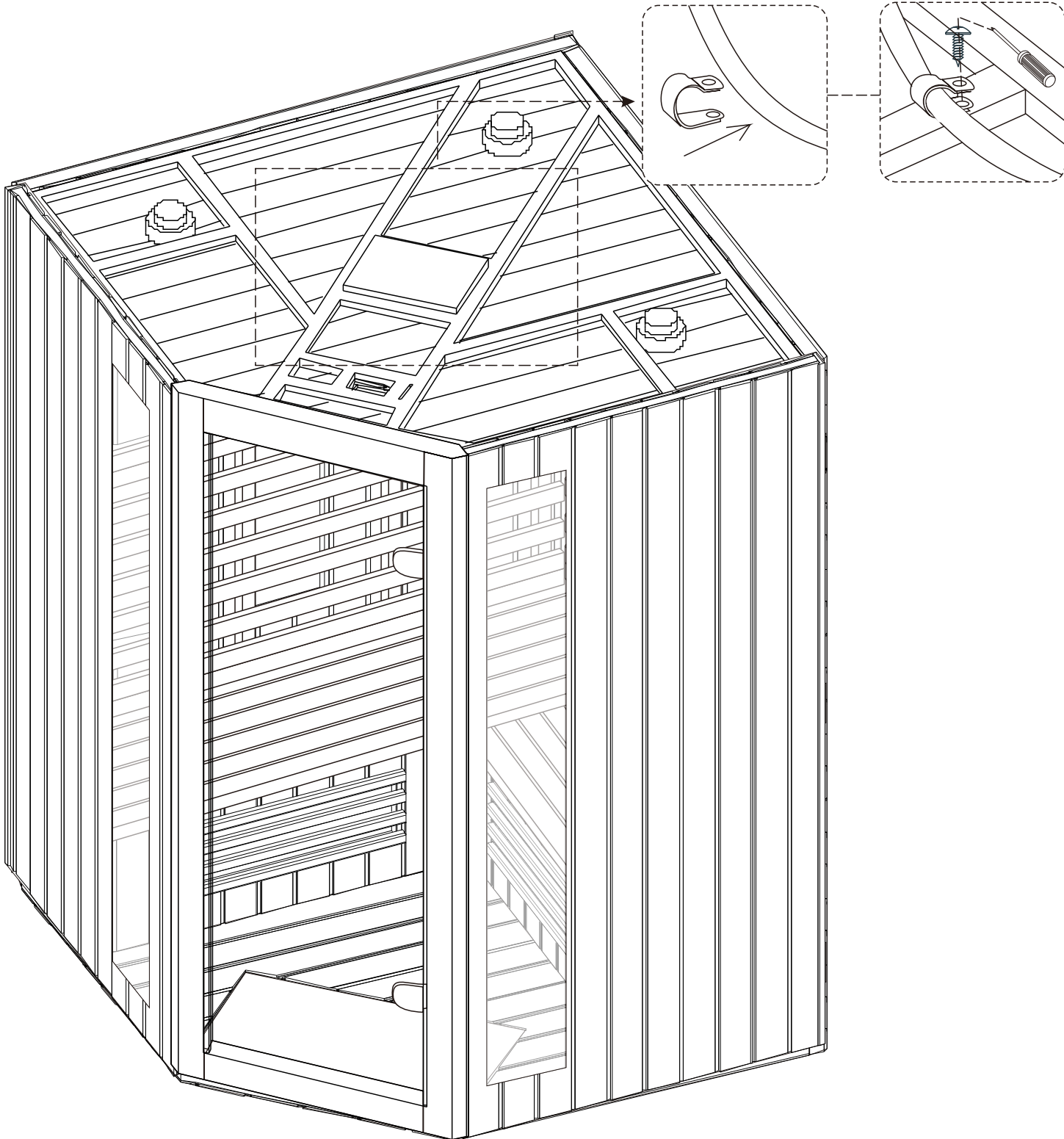

Etape 12

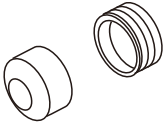
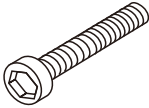
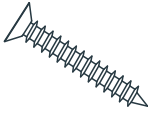
			 ST 4X35	
15	X1 14	X2 16	X2 21	X2

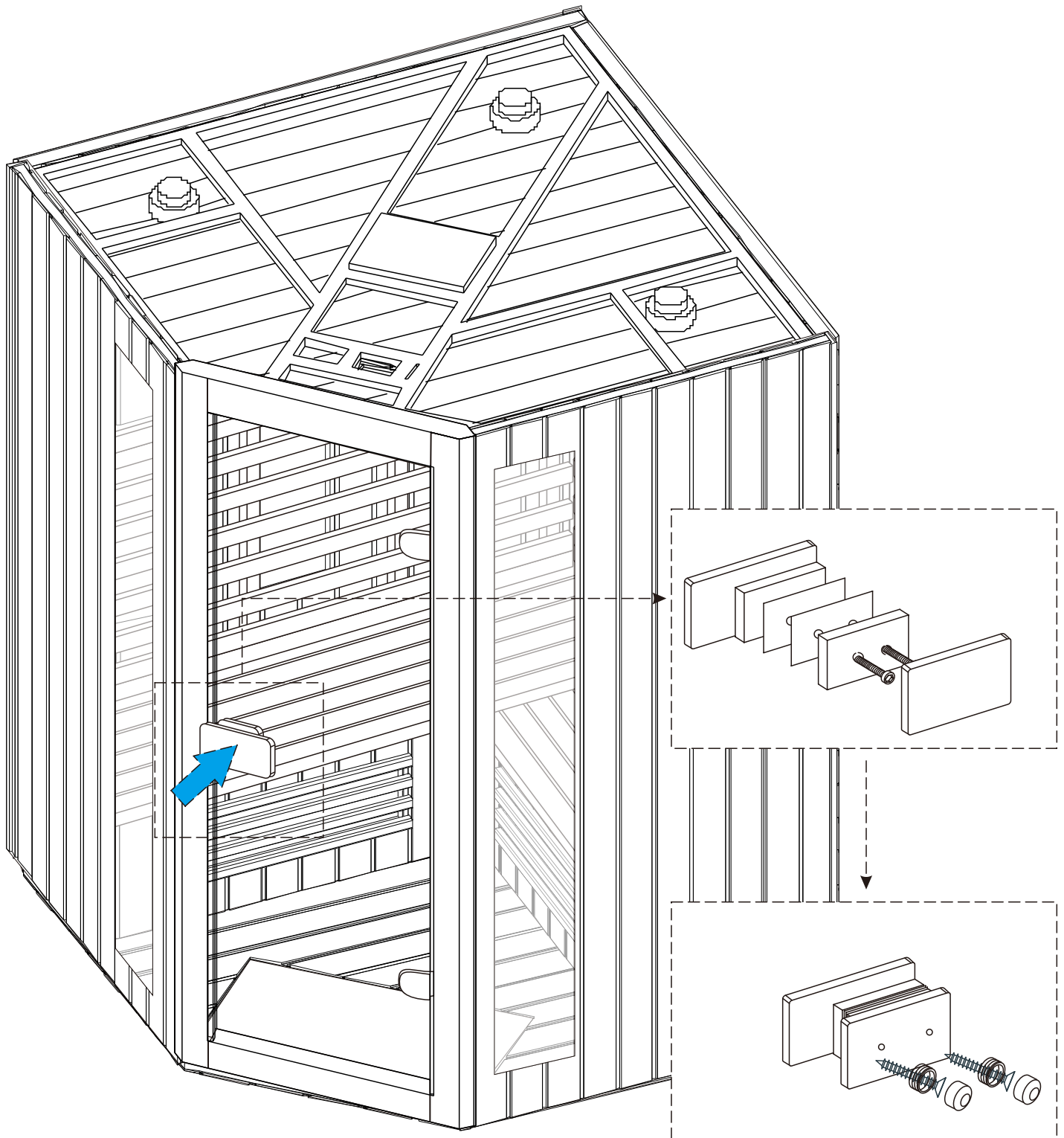

P13